







Assembly code	Assembly revision	Assembly image
ASM2911A/0.D00	Cooking chamber	
ASM2916A/0.D00	External cover	
ASM2926A/0.D01	Electrical system	
ASM2921A/0.D01	Door	

ASM2911A/0.D00 - Cooking chamber

FRONT

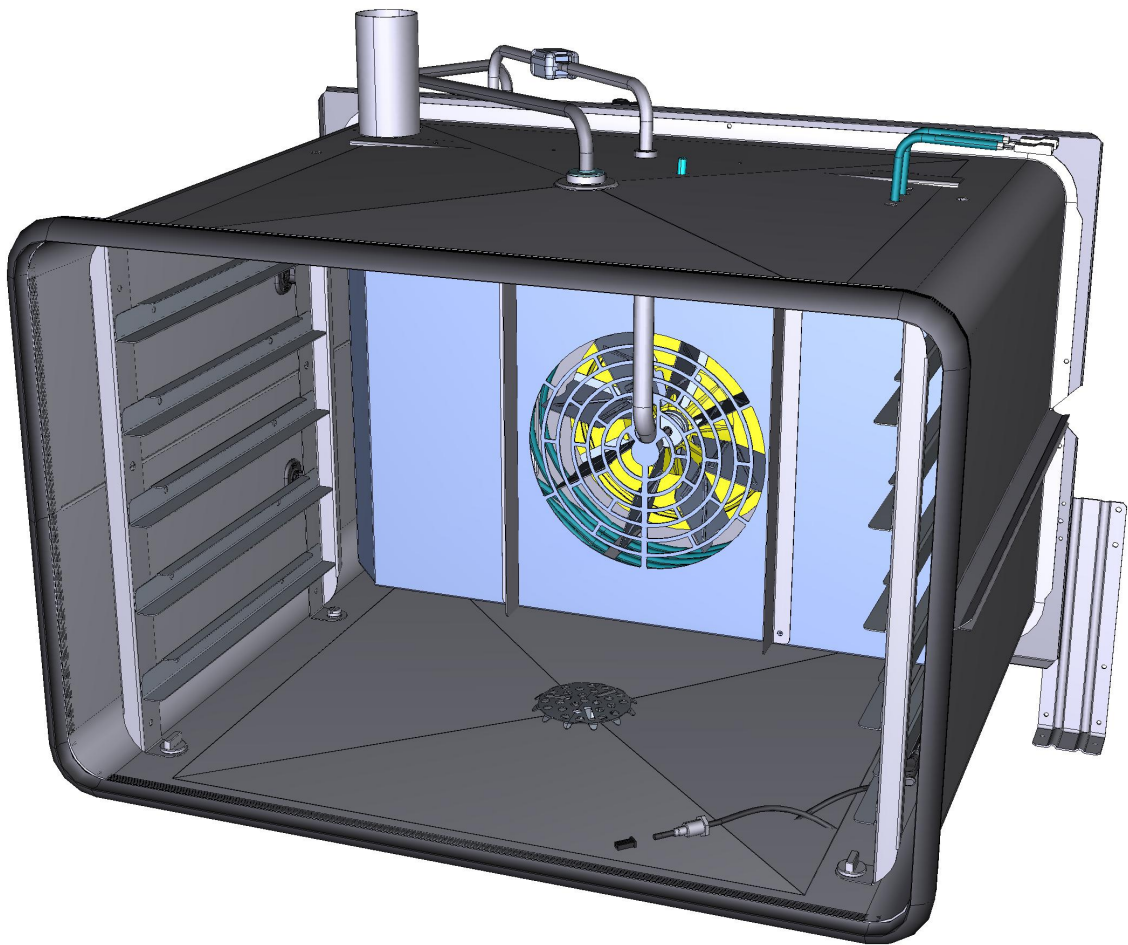



ASM2911A/0.D00 - Cooking chamber

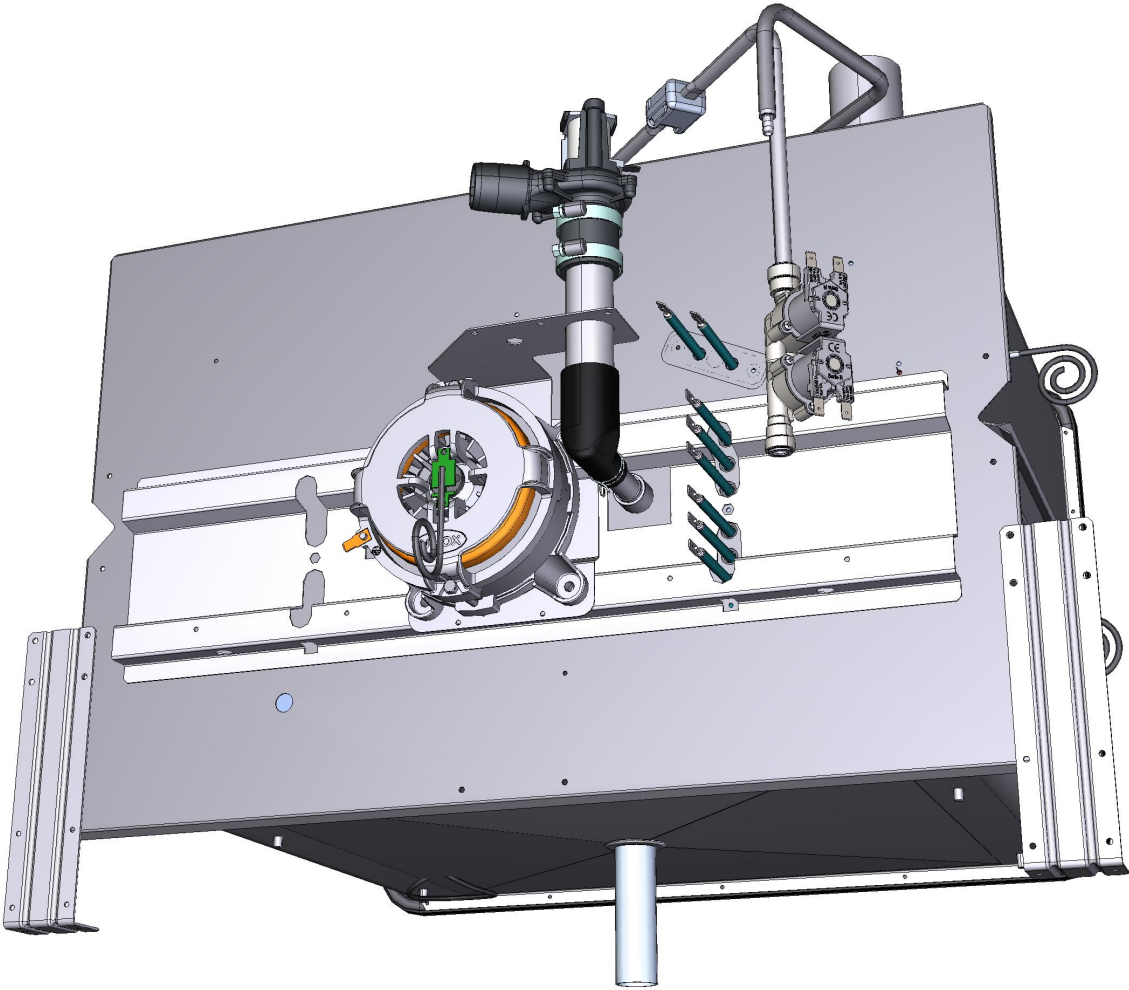

REAR



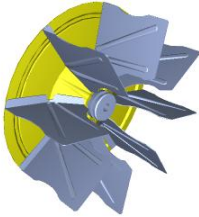

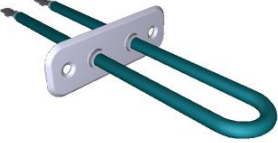

COMPONENT			SPARE PART																														
Code	Description	Image	Code	Description	Components list																												
TB2951A	XEVC-0511-E INTERNAL WATER PIPE		TB2951A0	XEVC-0511-E INTERNAL WATER PIPE																													
0G1549B	XEVC-0511-E FAN GUARD WITH FLAPS		0G1549B0	XEVC-0511-E FAN GUARD WITH FLAPS																													
MT1012A	330W 230V MOTOR		KMT1012A	MIND.MAPS 330W 230V MOTOR KIT	<table border="1"> <thead> <tr> <th>Code</th> <th>Description</th> <th>Qty</th> <th>UOM</th> </tr> </thead> <tbody> <tr> <td>GN1140A2</td> <td>MOTOR HOLDER GASKET</td> <td>1</td> <td>PZ</td> </tr> <tr> <td>MT1012A0</td> <td>330W 230V MOTOR</td> <td>1</td> <td>PZ</td> </tr> <tr> <td>VI1077A1</td> <td></td> <td>1</td> <td>PZ</td> </tr> <tr> <td>VI1521A0</td> <td>STAINLESS STEEL WASHER D=6 6592</td> <td>1</td> <td>PZ</td> </tr> <tr> <td>VM1794A0</td> <td>250X4.8 PA66 BLACK CLAMP</td> <td>4</td> <td>PZ</td> </tr> <tr> <td>VM2103A0</td> <td>CLAMP LOCK</td> <td>4</td> <td>PZ</td> </tr> </tbody> </table>	Code	Description	Qty	UOM	GN1140A2	MOTOR HOLDER GASKET	1	PZ	MT1012A0	330W 230V MOTOR	1	PZ	VI1077A1		1	PZ	VI1521A0	STAINLESS STEEL WASHER D=6 6592	1	PZ	VM1794A0	250X4.8 PA66 BLACK CLAMP	4	PZ	VM2103A0	CLAMP LOCK	4	PZ
Code	Description	Qty	UOM																														
GN1140A2	MOTOR HOLDER GASKET	1	PZ																														
MT1012A0	330W 230V MOTOR	1	PZ																														
VI1077A1		1	PZ																														
VI1521A0	STAINLESS STEEL WASHER D=6 6592	1	PZ																														
VM1794A0	250X4.8 PA66 BLACK CLAMP	4	PZ																														
VM2103A0	CLAMP LOCK	4	PZ																														
0H7170A	MM MOTOR GLASS WOOL PLATE		0H7170A0	MM MOTOR GLASS WOOL PLATE																													
GN1140A	MOTOR HOLDER GASKET		KG1140A	5 PCS. MOTOR SUPP. GASKET KIT	<table border="1"> <thead> <tr> <th>Code</th> <th>Description</th> <th>Qty</th> <th>UOM</th> </tr> </thead> <tbody> <tr> <td>GN1140A2</td> <td>MOTOR HOLDER GASKET</td> <td>5</td> <td>PZ</td> </tr> </tbody> </table>	Code	Description	Qty	UOM	GN1140A2	MOTOR HOLDER GASKET	5	PZ																				
Code	Description	Qty	UOM																														
GN1140A2	MOTOR HOLDER GASKET	5	PZ																														

COMPONENT			SPARE PART														
Code	Description	Image	Code	Description	Components list												
0H4305A	ST. STEEL MOTOR SHAFT SEALING DIS		K0H4305A	SEALING DISC FOR MOTOR SHAFT KIT	<table border="1"> <thead> <tr> <th>Code</th> <th>Description</th> <th>Qty</th> <th>UOM</th> </tr> </thead> <tbody> <tr> <td>0H4305A1</td> <td>ST. STEEL MOTOR SHAFT SEALING DISC</td> <td>1</td> <td>PZ</td> </tr> </tbody> </table>	Code	Description	Qty	UOM	0H4305A1	ST. STEEL MOTOR SHAFT SEALING DISC	1	PZ				
					Code	Description	Qty	UOM									
					0H4305A1	ST. STEEL MOTOR SHAFT SEALING DISC	1	PZ									
					<table border="1"> <thead> <tr> <th>Code</th> <th>Description</th> <th>Qty</th> <th>UOM</th> </tr> </thead> <tbody> <tr> <td>GN1140A2</td> <td>MOTOR HOLDER GASKET</td> <td>1</td> <td>PZ</td> </tr> </tbody> </table>	Code	Description	Qty	UOM	GN1140A2	MOTOR HOLDER GASKET	1	PZ				
Code	Description	Qty	UOM														
GN1140A2	MOTOR HOLDER GASKET	1	PZ														
<table border="1"> <thead> <tr> <th>Code</th> <th>Description</th> <th>Qty</th> <th>UOM</th> </tr> </thead> <tbody> <tr> <td>SL1045A0</td> <td>S53 BLACK SILICONE - 80ML CARTRIDGE</td> <td>1</td> <td>PZ</td> </tr> </tbody> </table>	Code	Description	Qty	UOM	SL1045A0	S53 BLACK SILICONE - 80ML CARTRIDGE	1	PZ									
Code	Description	Qty	UOM														
SL1045A0	S53 BLACK SILICONE - 80ML CARTRIDGE	1	PZ														
<table border="1"> <thead> <tr> <th>Code</th> <th>Description</th> <th>Qty</th> <th>UOM</th> </tr> </thead> <tbody> <tr> <td>VI1220A1</td> <td>4,2X12 TCB SELF-TAPPIN G SCREW</td> <td>3</td> <td>PZ</td> </tr> </tbody> </table>	Code	Description	Qty	UOM	VI1220A1	4,2X12 TCB SELF-TAPPIN G SCREW	3	PZ									
Code	Description	Qty	UOM														
VI1220A1	4,2X12 TCB SELF-TAPPIN G SCREW	3	PZ														
VN1170A	D195 H80 8 BLADES FAN		KVN1170B	D195 H80 8 BLADES FAN + RING KIT	<table border="1"> <thead> <tr> <th>Code</th> <th>Description</th> <th>Qty</th> <th>UOM</th> </tr> </thead> <tbody> <tr> <td>VI1077A1</td> <td></td> <td>1</td> <td>PZ</td> </tr> <tr> <td>VI1521A0</td> <td>STAINLESS STEEL WASHER D=6 6592</td> <td>1</td> <td>PZ</td> </tr> </tbody> </table>	Code	Description	Qty	UOM	VI1077A1		1	PZ	VI1521A0	STAINLESS STEEL WASHER D=6 6592	1	PZ
					Code	Description	Qty	UOM									
			VI1077A1		1	PZ											
			VI1521A0	STAINLESS STEEL WASHER D=6 6592	1	PZ											
<table border="1"> <thead> <tr> <th>Code</th> <th>Description</th> <th>Qty</th> <th>UOM</th> </tr> </thead> <tbody> <tr> <td>VN1170B0</td> <td></td> <td>1</td> <td>PZ</td> </tr> </tbody> </table>	Code	Description	Qty	UOM	VN1170B0		1	PZ									
Code	Description	Qty	UOM														
VN1170B0		1	PZ														
KVN1170A	D195 H80 8 BLADES FAN KIT	<table border="1"> <thead> <tr> <th>Code</th> <th>Description</th> <th>Qty</th> <th>UOM</th> </tr> </thead> <tbody> <tr> <td>VI1077A1</td> <td></td> <td>1</td> <td>PZ</td> </tr> <tr> <td>VI1521A0</td> <td>STAINLESS STEEL WASHER D=6 6592</td> <td>1</td> <td>PZ</td> </tr> </tbody> </table>	Code	Description	Qty	UOM	VI1077A1		1	PZ	VI1521A0	STAINLESS STEEL WASHER D=6 6592	1	PZ			
		Code	Description	Qty	UOM												
VI1077A1		1	PZ														
VI1521A0	STAINLESS STEEL WASHER D=6 6592	1	PZ														
<table border="1"> <thead> <tr> <th>Code</th> <th>Description</th> <th>Qty</th> <th>UOM</th> </tr> </thead> <tbody> <tr> <td>VN1170A2</td> <td>D195 H80 8 BLADES FAN</td> <td>1</td> <td>PZ</td> </tr> </tbody> </table>	Code	Description	Qty	UOM	VN1170A2	D195 H80 8 BLADES FAN	1	PZ									
Code	Description	Qty	UOM														
VN1170A2	D195 H80 8 BLADES FAN	1	PZ														
PE1710B	MOTOR REVOLUTION AND DIRECTION SENSO		KPE1710B	MOTOR REVOLUTIONS SENSOR KIT	<table border="1"> <thead> <tr> <th>Code</th> <th>Description</th> <th>Qty</th> <th>UOM</th> </tr> </thead> <tbody> <tr> <td>PE1710B0</td> <td>MOTOR REVOLUTION AND DIRECTION SENSOR</td> <td>1</td> <td>PZ</td> </tr> </tbody> </table>	Code	Description	Qty	UOM	PE1710B0	MOTOR REVOLUTION AND DIRECTION SENSOR	1	PZ				
					Code	Description	Qty	UOM									
					PE1710B0	MOTOR REVOLUTION AND DIRECTION SENSOR	1	PZ									
					<table border="1"> <thead> <tr> <th>Code</th> <th>Description</th> <th>Qty</th> <th>UOM</th> </tr> </thead> <tbody> <tr> <td>VE1550A0</td> <td>5X3 MM NEODYMIUM MAGNET</td> <td>1</td> <td>PZ</td> </tr> </tbody> </table>	Code	Description	Qty	UOM	VE1550A0	5X3 MM NEODYMIUM MAGNET	1	PZ				
Code	Description	Qty	UOM														
VE1550A0	5X3 MM NEODYMIUM MAGNET	1	PZ														
<table border="1"> <thead> <tr> <th>Code</th> <th>Description</th> <th>Qty</th> <th>UOM</th> </tr> </thead> <tbody> <tr> <td>VI1966A0</td> <td>M4X14 FLATHEAD SCREW</td> <td>1</td> <td>PZ</td> </tr> </tbody> </table>	Code	Description	Qty	UOM	VI1966A0	M4X14 FLATHEAD SCREW	1	PZ									
Code	Description	Qty	UOM														
VI1966A0	M4X14 FLATHEAD SCREW	1	PZ														
<table border="1"> <thead> <tr> <th>Code</th> <th>Description</th> <th>Qty</th> <th>UOM</th> </tr> </thead> <tbody> <tr> <td>VM1635A0</td> <td>MAGNET HOLDING DIS</td> <td>1</td> <td>PZ</td> </tr> </tbody> </table>	Code	Description	Qty	UOM	VM1635A0	MAGNET HOLDING DIS	1	PZ									
Code	Description	Qty	UOM														
VM1635A0	MAGNET HOLDING DIS	1	PZ														



COMPONENT			SPARE PART																										
Code	Description	Image	Code	Description	Components list																								
VE1550A	5X3 MM NEODYMIUM MAGNET		VE1550A0	5X3 MM NEODYMIUM MAGNET																									
RS1215A	147W 105V D230 1 TURN FLAT ELEMEN		KRS1215A	147W 105V HEATING ELEMENT KIT	<table border="1"> <thead> <tr> <th>Code</th> <th>Description</th> <th>Qty</th> <th>UOM</th> </tr> </thead> <tbody> <tr> <td>GN1326A1</td> <td>ELEMENT SEALING</td> <td>1</td> <td>PZ</td> </tr> <tr> <td>RS1215A1</td> <td>147W 105V D230 1 TURN FLAT ELEMEN</td> <td>1</td> <td>PZ</td> </tr> <tr> <td>SL1045A0</td> <td>S53 BLACK SILICONE - 80ML CARTRIDGE</td> <td>1</td> <td>PZ</td> </tr> <tr> <td>VI1220A1</td> <td>4,2X12 TCB SELF-TAPPIN G SCREW</td> <td>2</td> <td>PZ</td> </tr> <tr> <td>VM2147A0</td> <td>ESD SPONGE PINK SMOOTH 410X343X15 M</td> <td>1</td> <td>PZ</td> </tr> </tbody> </table>	Code	Description	Qty	UOM	GN1326A1	ELEMENT SEALING	1	PZ	RS1215A1	147W 105V D230 1 TURN FLAT ELEMEN	1	PZ	SL1045A0	S53 BLACK SILICONE - 80ML CARTRIDGE	1	PZ	VI1220A1	4,2X12 TCB SELF-TAPPIN G SCREW	2	PZ	VM2147A0	ESD SPONGE PINK SMOOTH 410X343X15 M	1	PZ
Code	Description	Qty	UOM																										
GN1326A1	ELEMENT SEALING	1	PZ																										
RS1215A1	147W 105V D230 1 TURN FLAT ELEMEN	1	PZ																										
SL1045A0	S53 BLACK SILICONE - 80ML CARTRIDGE	1	PZ																										
VI1220A1	4,2X12 TCB SELF-TAPPIN G SCREW	2	PZ																										
VM2147A0	ESD SPONGE PINK SMOOTH 410X343X15 M	1	PZ																										
GN1326A	ELEMENT SEALING		KRS1261A	BL CL MOTOR BREAKING ELEMENT KIT	<table border="1"> <thead> <tr> <th>Code</th> <th>Description</th> <th>Qty</th> <th>UOM</th> </tr> </thead> <tbody> <tr> <td>GN1326A1</td> <td>ELEMENT SEALING</td> <td>1</td> <td>PZ</td> </tr> <tr> <td>RS1261A0</td> <td>BAKERLUX/CH EFLUX MOTOR BREAKING ELEMENT</td> <td>1</td> <td>PZ</td> </tr> <tr> <td>SL1045A0</td> <td>S53 BLACK SILICONE - 80ML CARTRIDGE</td> <td>1</td> <td>PZ</td> </tr> <tr> <td>VI1220A1</td> <td>4,2X12 TCB SELF-TAPPIN G SCREW</td> <td>2</td> <td>PZ</td> </tr> <tr> <td>VM2147A0</td> <td>ESD SPONGE PINK SMOOTH 410X343X15 M</td> <td>1</td> <td>PZ</td> </tr> </tbody> </table>	Code	Description	Qty	UOM	GN1326A1	ELEMENT SEALING	1	PZ	RS1261A0	BAKERLUX/CH EFLUX MOTOR BREAKING ELEMENT	1	PZ	SL1045A0	S53 BLACK SILICONE - 80ML CARTRIDGE	1	PZ	VI1220A1	4,2X12 TCB SELF-TAPPIN G SCREW	2	PZ	VM2147A0	ESD SPONGE PINK SMOOTH 410X343X15 M	1	PZ
Code	Description	Qty	UOM																										
GN1326A1	ELEMENT SEALING	1	PZ																										
RS1261A0	BAKERLUX/CH EFLUX MOTOR BREAKING ELEMENT	1	PZ																										
SL1045A0	S53 BLACK SILICONE - 80ML CARTRIDGE	1	PZ																										
VI1220A1	4,2X12 TCB SELF-TAPPIN G SCREW	2	PZ																										
VM2147A0	ESD SPONGE PINK SMOOTH 410X343X15 M	1	PZ																										
			KRS1215A	147W 105V HEATING ELEMENT KIT	<table border="1"> <thead> <tr> <th>Code</th> <th>Description</th> <th>Qty</th> <th>UOM</th> </tr> </thead> <tbody> <tr> <td>GN1326A1</td> <td>ELEMENT SEALING</td> <td>1</td> <td>PZ</td> </tr> <tr> <td>RS1215A1</td> <td>147W 105V D230 1 TURN FLAT ELEMEN</td> <td>1</td> <td>PZ</td> </tr> </tbody> </table>	Code	Description	Qty	UOM	GN1326A1	ELEMENT SEALING	1	PZ	RS1215A1	147W 105V D230 1 TURN FLAT ELEMEN	1	PZ												
Code	Description	Qty	UOM																										
GN1326A1	ELEMENT SEALING	1	PZ																										
RS1215A1	147W 105V D230 1 TURN FLAT ELEMEN	1	PZ																										

COMPONENT			SPARE PART																										
Code	Description	Image	Code	Description	Components list																								
GN1326A	ELEMENT SEALING		KRS1215A	147W 105V HEATING ELEMENT KIT	<table border="1"> <thead> <tr> <th>Code</th> <th>Description</th> <th>Qty</th> <th>UOM</th> </tr> </thead> <tbody> <tr> <td>SL1045A0</td> <td>S53 BLACK SILICONE - 80ML CARTRIDGE</td> <td>1</td> <td>PZ</td> </tr> <tr> <td>VI1220A1</td> <td>4,2X12 TCB SELF-TAPPIN G SCREW</td> <td>2</td> <td>PZ</td> </tr> <tr> <td>VM2147A0</td> <td>ESD SPONGE PINK SMOOTH 410X343X15 M</td> <td>1</td> <td>PZ</td> </tr> </tbody> </table>	Code	Description	Qty	UOM	SL1045A0	S53 BLACK SILICONE - 80ML CARTRIDGE	1	PZ	VI1220A1	4,2X12 TCB SELF-TAPPIN G SCREW	2	PZ	VM2147A0	ESD SPONGE PINK SMOOTH 410X343X15 M	1	PZ								
					Code	Description	Qty	UOM																					
					SL1045A0	S53 BLACK SILICONE - 80ML CARTRIDGE	1	PZ																					
			VI1220A1	4,2X12 TCB SELF-TAPPIN G SCREW	2	PZ																							
			VM2147A0	ESD SPONGE PINK SMOOTH 410X343X15 M	1	PZ																							
			KRS1095A	1.2KW HEATING ELEMENT KIT	<table border="1"> <thead> <tr> <th>Code</th> <th>Description</th> <th>Qty</th> <th>UOM</th> </tr> </thead> <tbody> <tr> <td>GN1326A1</td> <td>ELEMENT SEALING</td> <td>1</td> <td>PZ</td> </tr> <tr> <td>IP1385A0</td> <td></td> <td>1.200</td> <td>PZ</td> </tr> <tr> <td>RS1095A1</td> <td>HEATING ELEMENT 1200W 230V</td> <td>1</td> <td>PZ</td> </tr> <tr> <td>SL1045A0</td> <td>S53 BLACK SILICONE - 80ML CARTRIDGE</td> <td>1</td> <td>PZ</td> </tr> <tr> <td>VI1220A1</td> <td>4,2X12 TCB SELF-TAPPIN G SCREW</td> <td>2</td> <td>PZ</td> </tr> </tbody> </table>	Code	Description	Qty	UOM	GN1326A1	ELEMENT SEALING	1	PZ	IP1385A0		1.200	PZ	RS1095A1	HEATING ELEMENT 1200W 230V	1	PZ	SL1045A0	S53 BLACK SILICONE - 80ML CARTRIDGE	1	PZ	VI1220A1	4,2X12 TCB SELF-TAPPIN G SCREW	2	PZ
					Code	Description	Qty	UOM																					
					GN1326A1	ELEMENT SEALING	1	PZ																					
					IP1385A0		1.200	PZ																					
					RS1095A1	HEATING ELEMENT 1200W 230V	1	PZ																					
					SL1045A0	S53 BLACK SILICONE - 80ML CARTRIDGE	1	PZ																					
			VI1220A1	4,2X12 TCB SELF-TAPPIN G SCREW	2	PZ																							
			KRS1012A	1365W 120V HEATING ELEMENT KIT	<table border="1"> <thead> <tr> <th>Code</th> <th>Description</th> <th>Qty</th> <th>UOM</th> </tr> </thead> <tbody> <tr> <td>GN1326A1</td> <td>ELEMENT SEALING</td> <td>1</td> <td>PZ</td> </tr> <tr> <td>RS1012A0</td> <td>CIRCULAR ELEMENT 1365W 120V</td> <td>1</td> <td>PZ</td> </tr> <tr> <td>VI1220A1</td> <td>4,2X12 TCB SELF-TAPPIN G SCREW</td> <td>5</td> <td>PZ</td> </tr> <tr> <td>VM1794A0</td> <td>250X4.8 PA66 BLACK CLAMP</td> <td>2</td> <td>PZ</td> </tr> </tbody> </table>	Code	Description	Qty	UOM	GN1326A1	ELEMENT SEALING	1	PZ	RS1012A0	CIRCULAR ELEMENT 1365W 120V	1	PZ	VI1220A1	4,2X12 TCB SELF-TAPPIN G SCREW	5	PZ	VM1794A0	250X4.8 PA66 BLACK CLAMP	2	PZ				
					Code	Description	Qty	UOM																					
					GN1326A1	ELEMENT SEALING	1	PZ																					
RS1012A0	CIRCULAR ELEMENT 1365W 120V	1			PZ																								
VI1220A1	4,2X12 TCB SELF-TAPPIN G SCREW	5			PZ																								
VM1794A0	250X4.8 PA66 BLACK CLAMP	2	PZ																										
KRS1011A	XF003/010/013 HEATING ELEMENT KIT	<table border="1"> <thead> <tr> <th>Code</th> <th>Description</th> <th>Qty</th> <th>UOM</th> </tr> </thead> <tbody> <tr> <td>GN1326A1</td> <td>ELEMENT SEALING</td> <td>1</td> <td>PZ</td> </tr> <tr> <td>RS1011A0</td> <td>2560W 220-230V HEATING ELEMENT</td> <td>1</td> <td>PZ</td> </tr> <tr> <td>SL1045A0</td> <td>S53 BLACK SILICONE - 80ML CARTRIDGE</td> <td>1</td> <td>PZ</td> </tr> </tbody> </table>	Code	Description	Qty	UOM	GN1326A1	ELEMENT SEALING	1	PZ	RS1011A0	2560W 220-230V HEATING ELEMENT	1	PZ	SL1045A0	S53 BLACK SILICONE - 80ML CARTRIDGE	1	PZ											
		Code	Description	Qty	UOM																								
		GN1326A1	ELEMENT SEALING	1	PZ																								
		RS1011A0	2560W 220-230V HEATING ELEMENT	1	PZ																								
SL1045A0	S53 BLACK SILICONE - 80ML CARTRIDGE	1	PZ																										
		<table border="1"> <thead> <tr> <th>Code</th> <th>Description</th> <th>Qty</th> <th>UOM</th> </tr> </thead> <tbody> <tr> <td>VM2103A0</td> <td>CLAMP LOCK</td> <td>2</td> <td>PZ</td> </tr> <tr> <td>VI1220A1</td> <td>4,2X12 TCB SELF-TAPPIN G SCREW</td> <td>5</td> <td>PZ</td> </tr> </tbody> </table>	Code	Description	Qty	UOM	VM2103A0	CLAMP LOCK	2	PZ	VI1220A1	4,2X12 TCB SELF-TAPPIN G SCREW	5	PZ															
		Code	Description	Qty	UOM																								
VM2103A0	CLAMP LOCK	2	PZ																										
VI1220A1	4,2X12 TCB SELF-TAPPIN G SCREW	5	PZ																										





COMPONENT			SPARE PART																										
Code	Description	Image	Code	Description	Components list																								
GN1326A	ELEMENT SEALING		KRS1011A	XF003/010/013 HEATING ELEMENT KIT	<table border="1"> <thead> <tr> <th>Code</th> <th>Description</th> <th>Qty</th> <th>UOM</th> </tr> </thead> <tbody> <tr> <td>VM1794A0</td> <td>250X4.8 PA66 BLACK CLAMP</td> <td>2</td> <td>PZ</td> </tr> <tr> <td>VM2103A0</td> <td>CLAMP LOCK</td> <td>2</td> <td>PZ</td> </tr> </tbody> </table>	Code	Description	Qty	UOM	VM1794A0	250X4.8 PA66 BLACK CLAMP	2	PZ	VM2103A0	CLAMP LOCK	2	PZ												
			Code	Description	Qty	UOM																							
			VM1794A0	250X4.8 PA66 BLACK CLAMP	2	PZ																							
			VM2103A0	CLAMP LOCK	2	PZ																							
			KRS0090A	HEATING ELEMENT 1.26KW	<table border="1"> <thead> <tr> <th>Code</th> <th>Description</th> <th>Qty</th> <th>UOM</th> </tr> </thead> <tbody> <tr> <td>GN1326A1</td> <td>ELEMENT SEALING</td> <td>1</td> <td>PZ</td> </tr> <tr> <td>RS0090A0</td> <td>CIRC. HEAT. ELEMENT 1260W 220-230</td> <td>1</td> <td>PZ</td> </tr> <tr> <td>VI1220A1</td> <td>4,2X12 TCB SELF-TAPPIN G SCREW</td> <td>3</td> <td>PZ</td> </tr> <tr> <td>VM1794A0</td> <td>250X4.8 PA66 BLACK CLAMP</td> <td>2</td> <td>PZ</td> </tr> <tr> <td>VM2103A0</td> <td>CLAMP LOCK</td> <td>2</td> <td>PZ</td> </tr> </tbody> </table>	Code	Description	Qty	UOM	GN1326A1	ELEMENT SEALING	1	PZ	RS0090A0	CIRC. HEAT. ELEMENT 1260W 220-230	1	PZ	VI1220A1	4,2X12 TCB SELF-TAPPIN G SCREW	3	PZ	VM1794A0	250X4.8 PA66 BLACK CLAMP	2	PZ	VM2103A0	CLAMP LOCK	2	PZ
			Code	Description	Qty	UOM																							
			GN1326A1	ELEMENT SEALING	1	PZ																							
			RS0090A0	CIRC. HEAT. ELEMENT 1260W 220-230	1	PZ																							
			VI1220A1	4,2X12 TCB SELF-TAPPIN G SCREW	3	PZ																							
			VM1794A0	250X4.8 PA66 BLACK CLAMP	2	PZ																							
			VM2103A0	CLAMP LOCK	2	PZ																							
			KRS0050A	HEATING ELEMENT KIT 0.5KW	<table border="1"> <thead> <tr> <th>Code</th> <th>Description</th> <th>Qty</th> <th>UOM</th> </tr> </thead> <tbody> <tr> <td>GN1326A1</td> <td>ELEMENT SEALING</td> <td>1</td> <td>PZ</td> </tr> <tr> <td>IP1075A1</td> <td></td> <td>1</td> <td>PZ</td> </tr> <tr> <td>IP1080A1</td> <td></td> <td>1</td> <td>PZ</td> </tr> <tr> <td>RS0050A0</td> <td>HEAT. ELEMENT 500W 220-230V LIEV</td> <td>1</td> <td>PZ</td> </tr> <tr> <td>VI1220A1</td> <td>4,2X12 TCB SELF-TAPPIN G SCREW</td> <td>2</td> <td>PZ</td> </tr> </tbody> </table>	Code	Description	Qty	UOM	GN1326A1	ELEMENT SEALING	1	PZ	IP1075A1		1	PZ	IP1080A1		1	PZ	RS0050A0	HEAT. ELEMENT 500W 220-230V LIEV	1	PZ	VI1220A1	4,2X12 TCB SELF-TAPPIN G SCREW	2	PZ
Code	Description	Qty	UOM																										
GN1326A1	ELEMENT SEALING	1	PZ																										
IP1075A1		1	PZ																										
IP1080A1		1	PZ																										
RS0050A0	HEAT. ELEMENT 500W 220-230V LIEV	1	PZ																										
VI1220A1	4,2X12 TCB SELF-TAPPIN G SCREW	2	PZ																										
KRS0011A	HEATING ELEMENT 1.465KW RS0011A	<table border="1"> <thead> <tr> <th>Code</th> <th>Description</th> <th>Qty</th> <th>UOM</th> </tr> </thead> <tbody> <tr> <td>GN1326A1</td> <td>ELEMENT SEALING</td> <td>1</td> <td>PZ</td> </tr> <tr> <td>RS0011A0</td> <td>CIRC.HEAT. ELEMENT 1465W 220-230</td> <td>1</td> <td>PZ</td> </tr> <tr> <td>VI1220A1</td> <td>4,2X12 TCB SELF-TAPPIN G SCREW</td> <td>3</td> <td>PZ</td> </tr> <tr> <td>VM1794A0</td> <td>250X4.8 PA66 BLACK CLAMP</td> <td>2</td> <td>PZ</td> </tr> <tr> <td>VM2103A0</td> <td>CLAMP LOCK</td> <td>2</td> <td>PZ</td> </tr> </tbody> </table>	Code	Description	Qty	UOM	GN1326A1	ELEMENT SEALING	1	PZ	RS0011A0	CIRC.HEAT. ELEMENT 1465W 220-230	1	PZ	VI1220A1	4,2X12 TCB SELF-TAPPIN G SCREW	3	PZ	VM1794A0	250X4.8 PA66 BLACK CLAMP	2	PZ	VM2103A0	CLAMP LOCK	2	PZ			
Code	Description	Qty	UOM																										
GN1326A1	ELEMENT SEALING	1	PZ																										
RS0011A0	CIRC.HEAT. ELEMENT 1465W 220-230	1	PZ																										
VI1220A1	4,2X12 TCB SELF-TAPPIN G SCREW	3	PZ																										
VM1794A0	250X4.8 PA66 BLACK CLAMP	2	PZ																										
VM2103A0	CLAMP LOCK	2	PZ																										
KRS0010A	KIT HEATING ELEMENT RS10010A	<table border="1"> <thead> <tr> <th>Code</th> <th>Description</th> <th>Qty</th> <th>UOM</th> </tr> </thead> <tbody> <tr> <td>GN1326A1</td> <td>ELEMENT SEALING</td> <td>1</td> <td>PZ</td> </tr> <tr> <td>IP1075A1</td> <td></td> <td>1</td> <td>PZ</td> </tr> <tr> <td>IP1080A1</td> <td></td> <td>5</td> <td>PZ</td> </tr> <tr> <td>RS0010A0</td> <td>CIRC.HEAT. ELEMENT 2560W - 220-230 V</td> <td>1</td> <td>PZ</td> </tr> <tr> <td>VI1220A1</td> <td>4,2X12 TCB SELF-TAPPIN G SCREW</td> <td>3</td> <td>PZ</td> </tr> </tbody> </table>	Code	Description	Qty	UOM	GN1326A1	ELEMENT SEALING	1	PZ	IP1075A1		1	PZ	IP1080A1		5	PZ	RS0010A0	CIRC.HEAT. ELEMENT 2560W - 220-230 V	1	PZ	VI1220A1	4,2X12 TCB SELF-TAPPIN G SCREW	3	PZ			
Code	Description	Qty	UOM																										
GN1326A1	ELEMENT SEALING	1	PZ																										
IP1075A1		1	PZ																										
IP1080A1		5	PZ																										
RS0010A0	CIRC.HEAT. ELEMENT 2560W - 220-230 V	1	PZ																										
VI1220A1	4,2X12 TCB SELF-TAPPIN G SCREW	3	PZ																										













COMPONENT			SPARE PART																														
Code	Description	Image	Code	Description	Components list																												
GN1326A	ELEMENT SEALING		KG1326A	HEATING ELEMENT GASKET 5 PCS KIT	<table border="1"> <thead> <tr> <th>Code</th> <th>Description</th> <th>Qty</th> <th>UOM</th> </tr> </thead> <tbody> <tr> <td>GN1326A1</td> <td>ELEMENT SEALING</td> <td>5</td> <td>PZ</td> </tr> </tbody> </table>	Code	Description	Qty	UOM	GN1326A1	ELEMENT SEALING	5	PZ																				
Code	Description	Qty	UOM																														
GN1326A1	ELEMENT SEALING	5	PZ																														
GN1285A	NTC TEMPERATURE PROBE SEALING		KTR1106A	L2000 CHAMBER TEMPERATURE PROBE KIT	<table border="1"> <thead> <tr> <th>Code</th> <th>Description</th> <th>Qty</th> <th>UOM</th> </tr> </thead> <tbody> <tr> <td>GN1285A0</td> <td>NTC TEMPERATUR E PROBE SEALING</td> <td>1</td> <td>PZ</td> </tr> <tr> <td>SL1045A0</td> <td>S53 BLACK SILICONE - 80ML CARTRIDGE</td> <td>1</td> <td>PZ</td> </tr> <tr> <td>TR1106A3</td> <td>PT100 L=2000 TEMPERATUR E PROBE</td> <td>1</td> <td>PZ</td> </tr> <tr> <td>VI1220A1</td> <td>4,2X12 TCB SELF-TAPPIN G SCREW</td> <td>2</td> <td>PZ</td> </tr> <tr> <td>VM1465A0</td> <td>CHEFTOP TEMPERATUR E PROBE COVER</td> <td>1</td> <td>PZ</td> </tr> </tbody> </table>	Code	Description	Qty	UOM	GN1285A0	NTC TEMPERATUR E PROBE SEALING	1	PZ	SL1045A0	S53 BLACK SILICONE - 80ML CARTRIDGE	1	PZ	TR1106A3	PT100 L=2000 TEMPERATUR E PROBE	1	PZ	VI1220A1	4,2X12 TCB SELF-TAPPIN G SCREW	2	PZ	VM1465A0	CHEFTOP TEMPERATUR E PROBE COVER	1	PZ				
Code	Description	Qty	UOM																														
GN1285A0	NTC TEMPERATUR E PROBE SEALING	1	PZ																														
SL1045A0	S53 BLACK SILICONE - 80ML CARTRIDGE	1	PZ																														
TR1106A3	PT100 L=2000 TEMPERATUR E PROBE	1	PZ																														
VI1220A1	4,2X12 TCB SELF-TAPPIN G SCREW	2	PZ																														
VM1465A0	CHEFTOP TEMPERATUR E PROBE COVER	1	PZ																														
			KTR1105A	L1000 CHAMBER TEMPERATURE PROBE KIT	<table border="1"> <thead> <tr> <th>Code</th> <th>Description</th> <th>Qty</th> <th>UOM</th> </tr> </thead> <tbody> <tr> <td>GN1120A0</td> <td>TEMPERATUR E PROBE NTC SEAL</td> <td>1</td> <td>PZ</td> </tr> <tr> <td>GN1285A0</td> <td>NTC TEMPERATUR E PROBE SEALING</td> <td>1</td> <td>PZ</td> </tr> <tr> <td>SL1045A0</td> <td>S53 BLACK SILICONE - 80ML CARTRIDGE</td> <td>1</td> <td>PZ</td> </tr> <tr> <td>TR1105A3</td> <td>L=1000 PT1000 TEMPERATUR E PROBE</td> <td>1</td> <td>PZ</td> </tr> <tr> <td>VI1220A1</td> <td>4,2X12 TCB SELF-TAPPIN G SCREW</td> <td>2</td> <td>PZ</td> </tr> <tr> <td>VM1465A0</td> <td>CHEFTOP TEMPERATUR E PROBE COVER</td> <td>1</td> <td>PZ</td> </tr> </tbody> </table>	Code	Description	Qty	UOM	GN1120A0	TEMPERATUR E PROBE NTC SEAL	1	PZ	GN1285A0	NTC TEMPERATUR E PROBE SEALING	1	PZ	SL1045A0	S53 BLACK SILICONE - 80ML CARTRIDGE	1	PZ	TR1105A3	L=1000 PT1000 TEMPERATUR E PROBE	1	PZ	VI1220A1	4,2X12 TCB SELF-TAPPIN G SCREW	2	PZ	VM1465A0	CHEFTOP TEMPERATUR E PROBE COVER	1	PZ
Code	Description	Qty	UOM																														
GN1120A0	TEMPERATUR E PROBE NTC SEAL	1	PZ																														
GN1285A0	NTC TEMPERATUR E PROBE SEALING	1	PZ																														
SL1045A0	S53 BLACK SILICONE - 80ML CARTRIDGE	1	PZ																														
TR1105A3	L=1000 PT1000 TEMPERATUR E PROBE	1	PZ																														
VI1220A1	4,2X12 TCB SELF-TAPPIN G SCREW	2	PZ																														
VM1465A0	CHEFTOP TEMPERATUR E PROBE COVER	1	PZ																														

COMPONENT			SPARE PART																														
Code	Description	Image	Code	Description	Components list																												
GN1285A	NTC TEMPERATURE PROBE SEALING		KTR1096A	TEMPERATURE PROBE KIT L=1500	<table border="1"> <thead> <tr> <th>Code</th> <th>Description</th> <th>Qty</th> <th>UOM</th> </tr> </thead> <tbody> <tr> <td>GN1120A0</td> <td>TEMPERATUR E PROBE NTC SEAL</td> <td>1</td> <td>PZ</td> </tr> <tr> <td>GN1285A0</td> <td>NTC TEMPERATUR E PROBE SEALING</td> <td>2</td> <td>PZ</td> </tr> <tr> <td>SL1045A0</td> <td>S53 BLACK SILICONE - 80ML CARTRIDGE</td> <td>1</td> <td>PZ</td> </tr> <tr> <td>TR1096A0</td> <td></td> <td>1</td> <td>PZ</td> </tr> <tr> <td>VI1220A1</td> <td>4,2X12 TCB SELF-TAPPIN G SCREW</td> <td>2</td> <td>PZ</td> </tr> <tr> <td>VM1465A0</td> <td>CHEFTOP TEMPERATUR E PROBE COVER</td> <td>1</td> <td>PZ</td> </tr> </tbody> </table>	Code	Description	Qty	UOM	GN1120A0	TEMPERATUR E PROBE NTC SEAL	1	PZ	GN1285A0	NTC TEMPERATUR E PROBE SEALING	2	PZ	SL1045A0	S53 BLACK SILICONE - 80ML CARTRIDGE	1	PZ	TR1096A0		1	PZ	VI1220A1	4,2X12 TCB SELF-TAPPIN G SCREW	2	PZ	VM1465A0	CHEFTOP TEMPERATUR E PROBE COVER	1	PZ
			Code	Description	Qty	UOM																											
			GN1120A0	TEMPERATUR E PROBE NTC SEAL	1	PZ																											
GN1285A0	NTC TEMPERATUR E PROBE SEALING	2	PZ																														
SL1045A0	S53 BLACK SILICONE - 80ML CARTRIDGE	1	PZ																														
TR1096A0		1	PZ																														
VI1220A1	4,2X12 TCB SELF-TAPPIN G SCREW	2	PZ																														
VM1465A0	CHEFTOP TEMPERATUR E PROBE COVER	1	PZ																														
KTR1095A	TEMPERATURE PROBE KIT	<table border="1"> <thead> <tr> <th>Code</th> <th>Description</th> <th>Qty</th> <th>UOM</th> </tr> </thead> <tbody> <tr> <td>GN1120A0</td> <td>TEMPERATUR E PROBE NTC SEAL</td> <td>1</td> <td>PZ</td> </tr> <tr> <td>GN1285A0</td> <td>NTC TEMPERATUR E PROBE SEALING</td> <td>1</td> <td>PZ</td> </tr> <tr> <td>SL1045A0</td> <td>S53 BLACK SILICONE - 80ML CARTRIDGE</td> <td>1</td> <td>PZ</td> </tr> <tr> <td>TR1095A0</td> <td>TEMPERATUR E PROBE NTC 150 L=1050</td> <td>1</td> <td>PZ</td> </tr> <tr> <td>VI1220A1</td> <td>4,2X12 TCB SELF-TAPPIN G SCREW</td> <td>2</td> <td>PZ</td> </tr> <tr> <td>VM1465A0</td> <td>CHEFTOP TEMPERATUR E PROBE COVER</td> <td>1</td> <td>PZ</td> </tr> </tbody> </table>	Code	Description	Qty	UOM	GN1120A0	TEMPERATUR E PROBE NTC SEAL	1	PZ	GN1285A0	NTC TEMPERATUR E PROBE SEALING	1	PZ	SL1045A0	S53 BLACK SILICONE - 80ML CARTRIDGE	1	PZ	TR1095A0	TEMPERATUR E PROBE NTC 150 L=1050	1	PZ	VI1220A1	4,2X12 TCB SELF-TAPPIN G SCREW	2	PZ	VM1465A0	CHEFTOP TEMPERATUR E PROBE COVER	1	PZ			
Code	Description	Qty	UOM																														
GN1120A0	TEMPERATUR E PROBE NTC SEAL	1	PZ																														
GN1285A0	NTC TEMPERATUR E PROBE SEALING	1	PZ																														
SL1045A0	S53 BLACK SILICONE - 80ML CARTRIDGE	1	PZ																														
TR1095A0	TEMPERATUR E PROBE NTC 150 L=1050	1	PZ																														
VI1220A1	4,2X12 TCB SELF-TAPPIN G SCREW	2	PZ																														
VM1465A0	CHEFTOP TEMPERATUR E PROBE COVER	1	PZ																														
KTR1002A	PT100 L1000 TEMPERATURE PROBE KIT	<table border="1"> <thead> <tr> <th>Code</th> <th>Description</th> <th>Qty</th> <th>UOM</th> </tr> </thead> <tbody> <tr> <td>GN1285A0</td> <td>NTC TEMPERATUR E PROBE SEALING</td> <td>2</td> <td>PZ</td> </tr> <tr> <td>SL1045A0</td> <td>S53 BLACK SILICONE - 80ML CARTRIDGE</td> <td>1</td> <td>PZ</td> </tr> <tr> <td>TR1002A0</td> <td>TEMPERATUR E PROBE UL PT100 L1000</td> <td>1</td> <td>PZ</td> </tr> </tbody> </table>	Code	Description	Qty	UOM	GN1285A0	NTC TEMPERATUR E PROBE SEALING	2	PZ	SL1045A0	S53 BLACK SILICONE - 80ML CARTRIDGE	1	PZ	TR1002A0	TEMPERATUR E PROBE UL PT100 L1000	1	PZ															
Code	Description	Qty	UOM																														
GN1285A0	NTC TEMPERATUR E PROBE SEALING	2	PZ																														
SL1045A0	S53 BLACK SILICONE - 80ML CARTRIDGE	1	PZ																														
TR1002A0	TEMPERATUR E PROBE UL PT100 L1000	1	PZ																														

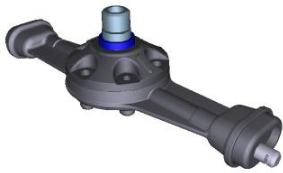
COMPONENT			SPARE PART																										
Code	Description	Image	Code	Description	Components list																								
GN1285A	NTC TEMPERATURE PROBE SEALING		KTR1002A	PT100 L1000 TEMPERATURE PROBE KIT	<table border="1"> <thead> <tr> <th>Code</th> <th>Description</th> <th>Qty</th> <th>UOM</th> </tr> </thead> <tbody> <tr> <td>VI1220A1</td> <td>4,2X12 TCB SELF-TAPPIN G SCREW</td> <td>2</td> <td>PZ</td> </tr> <tr> <td>VM1465A0</td> <td>CHEFTOP TEMPERATUR E PROBE COVER</td> <td>1</td> <td>PZ</td> </tr> </tbody> </table>	Code	Description	Qty	UOM	VI1220A1	4,2X12 TCB SELF-TAPPIN G SCREW	2	PZ	VM1465A0	CHEFTOP TEMPERATUR E PROBE COVER	1	PZ												
Code	Description	Qty	UOM																										
VI1220A1	4,2X12 TCB SELF-TAPPIN G SCREW	2	PZ																										
VM1465A0	CHEFTOP TEMPERATUR E PROBE COVER	1	PZ																										
TR1106A	PT100 L=2000 TEMPERATURE PROBE		KTR1106A	L2000 CHAMBER TEMPERATURE PROBE KIT	<table border="1"> <thead> <tr> <th>Code</th> <th>Description</th> <th>Qty</th> <th>UOM</th> </tr> </thead> <tbody> <tr> <td>GN1285A0</td> <td>NTC TEMPERATUR E PROBE SEALING</td> <td>1</td> <td>PZ</td> </tr> <tr> <td>SL1045A0</td> <td>S53 BLACK SILICONE - 80ML CARTRIDGE</td> <td>1</td> <td>PZ</td> </tr> <tr> <td>TR1106A3</td> <td>PT100 L=2000 TEMPERATUR E PROBE</td> <td>1</td> <td>PZ</td> </tr> <tr> <td>VI1220A1</td> <td>4,2X12 TCB SELF-TAPPIN G SCREW</td> <td>2</td> <td>PZ</td> </tr> <tr> <td>VM1465A0</td> <td>CHEFTOP TEMPERATUR E PROBE COVER</td> <td>1</td> <td>PZ</td> </tr> </tbody> </table>	Code	Description	Qty	UOM	GN1285A0	NTC TEMPERATUR E PROBE SEALING	1	PZ	SL1045A0	S53 BLACK SILICONE - 80ML CARTRIDGE	1	PZ	TR1106A3	PT100 L=2000 TEMPERATUR E PROBE	1	PZ	VI1220A1	4,2X12 TCB SELF-TAPPIN G SCREW	2	PZ	VM1465A0	CHEFTOP TEMPERATUR E PROBE COVER	1	PZ
Code	Description	Qty	UOM																										
GN1285A0	NTC TEMPERATUR E PROBE SEALING	1	PZ																										
SL1045A0	S53 BLACK SILICONE - 80ML CARTRIDGE	1	PZ																										
TR1106A3	PT100 L=2000 TEMPERATUR E PROBE	1	PZ																										
VI1220A1	4,2X12 TCB SELF-TAPPIN G SCREW	2	PZ																										
VM1465A0	CHEFTOP TEMPERATUR E PROBE COVER	1	PZ																										
VM1464A	CT BT TEMPERATURE PROBE COVER		KVM1464A	CT BT TEMPERATURE PROBE COVER KIT	<table border="1"> <thead> <tr> <th>Code</th> <th>Description</th> <th>Qty</th> <th>UOM</th> </tr> </thead> <tbody> <tr> <td>VM1464A0</td> <td>CT BT TEMPERATUR E PROBE COVER</td> <td>1</td> <td>PZ</td> </tr> </tbody> </table>	Code	Description	Qty	UOM	VM1464A0	CT BT TEMPERATUR E PROBE COVER	1	PZ																
Code	Description	Qty	UOM																										
VM1464A0	CT BT TEMPERATUR E PROBE COVER	1	PZ																										
GN1531A	THERMOSTAT BULB INLET SEALING		KTR1136A	SAFETY UNIP.THERMOSTAT KIT	<table border="1"> <thead> <tr> <th>Code</th> <th>Description</th> <th>Qty</th> <th>UOM</th> </tr> </thead> <tbody> <tr> <td>0H7030A0</td> <td>THERMOSTAT BULB INLET COVER</td> <td>1</td> <td>PZ</td> </tr> <tr> <td>GN1531A0</td> <td>THERMOSTAT BULB INLET SEALING</td> <td>1</td> <td>PZ</td> </tr> <tr> <td>SL1045A0</td> <td>S53 BLACK SILICONE - 80ML CARTRIDGE</td> <td>1</td> <td>PZ</td> </tr> <tr> <td>TR1136A0</td> <td>330°C 1 POLE SAFETY THERMOSTAT</td> <td>1</td> <td>PZ</td> </tr> <tr> <td>VI1220A1</td> <td>4,2X12 TCB SELF-TAPPIN G SCREW</td> <td>3</td> <td>PZ</td> </tr> </tbody> </table>	Code	Description	Qty	UOM	0H7030A0	THERMOSTAT BULB INLET COVER	1	PZ	GN1531A0	THERMOSTAT BULB INLET SEALING	1	PZ	SL1045A0	S53 BLACK SILICONE - 80ML CARTRIDGE	1	PZ	TR1136A0	330°C 1 POLE SAFETY THERMOSTAT	1	PZ	VI1220A1	4,2X12 TCB SELF-TAPPIN G SCREW	3	PZ
Code	Description	Qty	UOM																										
0H7030A0	THERMOSTAT BULB INLET COVER	1	PZ																										
GN1531A0	THERMOSTAT BULB INLET SEALING	1	PZ																										
SL1045A0	S53 BLACK SILICONE - 80ML CARTRIDGE	1	PZ																										
TR1136A0	330°C 1 POLE SAFETY THERMOSTAT	1	PZ																										
VI1220A1	4,2X12 TCB SELF-TAPPIN G SCREW	3	PZ																										





COMPONENT			SPARE PART																																		
Code	Description	Image	Code	Description	Components list																																
0H7030A	THERMOSTAT BULB INLET COVER		K0H7030A	THERMOSTAT BULB INLET COVER KIT	<table border="1"> <thead> <tr> <th>Code</th> <th>Description</th> <th>Qty</th> <th>UOM</th> </tr> </thead> <tbody> <tr> <td>0H7030A0</td> <td>THERMOSTAT BULB INLET COVER</td> <td>1</td> <td>PZ</td> </tr> </tbody> </table>	Code	Description	Qty	UOM	0H7030A0	THERMOSTAT BULB INLET COVER	1	PZ																								
Code	Description	Qty	UOM																																		
0H7030A0	THERMOSTAT BULB INLET COVER	1	PZ																																		
GRL1390A	5 GN1/1 LEFT LATERAL SUPPORT		KGRL1390A	MIND.MAPS 5 GN1/1 LATERAL SUPPORTS KIT	<table border="1"> <thead> <tr> <th>Code</th> <th>Description</th> <th>Qty</th> <th>UOM</th> </tr> </thead> <tbody> <tr> <td>0H4030A0</td> <td>L.287 TRAYS GUIDE PROFIL</td> <td>10</td> <td>PZ</td> </tr> <tr> <td>0H4420A0</td> <td>STAINLESS STEEL CORE TEMPERATUR</td> <td>1</td> <td>PZ</td> </tr> <tr> <td>0H7300A0</td> <td></td> <td>2</td> <td>PZ</td> </tr> <tr> <td>0H7301A0</td> <td></td> <td>2</td> <td>PZ</td> </tr> <tr> <td>IP1508A0</td> <td></td> <td>2</td> <td>PZ</td> </tr> <tr> <td>IP1508A1</td> <td></td> <td>2</td> <td>M</td> </tr> <tr> <td>VM1059A1</td> <td></td> <td>1.500</td> <td>M</td> </tr> </tbody> </table>	Code	Description	Qty	UOM	0H4030A0	L.287 TRAYS GUIDE PROFIL	10	PZ	0H4420A0	STAINLESS STEEL CORE TEMPERATUR	1	PZ	0H7300A0		2	PZ	0H7301A0		2	PZ	IP1508A0		2	PZ	IP1508A1		2	M	VM1059A1		1.500	M
Code	Description	Qty	UOM																																		
0H4030A0	L.287 TRAYS GUIDE PROFIL	10	PZ																																		
0H4420A0	STAINLESS STEEL CORE TEMPERATUR	1	PZ																																		
0H7300A0		2	PZ																																		
0H7301A0		2	PZ																																		
IP1508A0		2	PZ																																		
IP1508A1		2	M																																		
VM1059A1		1.500	M																																		
GRL1389A	5 GN1/1 RIGHT LATERAL SUPPORT		KGRL1390A	MIND.MAPS 5 GN1/1 LATERAL SUPPORTS KIT	<table border="1"> <thead> <tr> <th>Code</th> <th>Description</th> <th>Qty</th> <th>UOM</th> </tr> </thead> <tbody> <tr> <td>0H4030A0</td> <td>L.287 TRAYS GUIDE PROFIL</td> <td>10</td> <td>PZ</td> </tr> <tr> <td>0H4420A0</td> <td>STAINLESS STEEL CORE TEMPERATUR</td> <td>1</td> <td>PZ</td> </tr> <tr> <td>0H7300A0</td> <td></td> <td>2</td> <td>PZ</td> </tr> <tr> <td>0H7301A0</td> <td></td> <td>2</td> <td>PZ</td> </tr> <tr> <td>IP1508A0</td> <td></td> <td>2</td> <td>PZ</td> </tr> <tr> <td>IP1508A1</td> <td></td> <td>2</td> <td>M</td> </tr> <tr> <td>VM1059A1</td> <td></td> <td>1.500</td> <td>M</td> </tr> </tbody> </table>	Code	Description	Qty	UOM	0H4030A0	L.287 TRAYS GUIDE PROFIL	10	PZ	0H4420A0	STAINLESS STEEL CORE TEMPERATUR	1	PZ	0H7300A0		2	PZ	0H7301A0		2	PZ	IP1508A0		2	PZ	IP1508A1		2	M	VM1059A1		1.500	M
Code	Description	Qty	UOM																																		
0H4030A0	L.287 TRAYS GUIDE PROFIL	10	PZ																																		
0H4420A0	STAINLESS STEEL CORE TEMPERATUR	1	PZ																																		
0H7300A0		2	PZ																																		
0H7301A0		2	PZ																																		
IP1508A0		2	PZ																																		
IP1508A1		2	M																																		
VM1059A1		1.500	M																																		
TR1040A	L=1320 CORE PROB		KTR1040A	MOLDED CORE PROBE KIT L=1320	<table border="1"> <thead> <tr> <th>Code</th> <th>Description</th> <th>Qty</th> <th>UOM</th> </tr> </thead> <tbody> <tr> <td>0H7374A0</td> <td>CORE PROBE CABLE PLATE</td> <td>1</td> <td>PZ</td> </tr> <tr> <td>TR1040A2</td> <td>L=1320 CORE PROBE</td> <td>1</td> <td>PZ</td> </tr> </tbody> </table>	Code	Description	Qty	UOM	0H7374A0	CORE PROBE CABLE PLATE	1	PZ	TR1040A2	L=1320 CORE PROBE	1	PZ																				
Code	Description	Qty	UOM																																		
0H7374A0	CORE PROBE CABLE PLATE	1	PZ																																		
TR1040A2	L=1320 CORE PROBE	1	PZ																																		
VL1037A	WASHING SYSTEM ROTOR		KVL1037A	WASHING SYSTEM ROTOR KIT	<table border="1"> <thead> <tr> <th>Code</th> <th>Description</th> <th>Qty</th> <th>UOM</th> </tr> </thead> <tbody> <tr> <td>GN1416B0</td> <td>WASHING SYSTEM ROTOR BEARING</td> <td>1</td> <td>PZ</td> </tr> <tr> <td>TF1065B0</td> <td>WASHING SYSTEM ROTOR PIVOT</td> <td>1</td> <td>PZ</td> </tr> <tr> <td>TF1066A1</td> <td>WASHING SYSTEM ROTOR BUSH</td> <td>1</td> <td>PZ</td> </tr> </tbody> </table>	Code	Description	Qty	UOM	GN1416B0	WASHING SYSTEM ROTOR BEARING	1	PZ	TF1065B0	WASHING SYSTEM ROTOR PIVOT	1	PZ	TF1066A1	WASHING SYSTEM ROTOR BUSH	1	PZ																
Code	Description	Qty	UOM																																		
GN1416B0	WASHING SYSTEM ROTOR BEARING	1	PZ																																		
TF1065B0	WASHING SYSTEM ROTOR PIVOT	1	PZ																																		
TF1066A1	WASHING SYSTEM ROTOR BUSH	1	PZ																																		

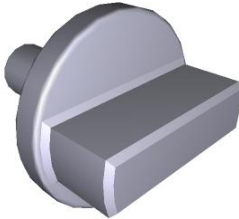
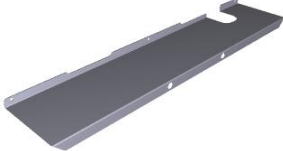
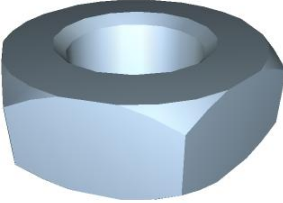
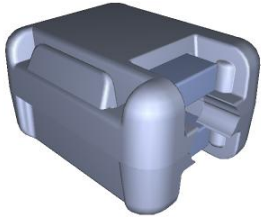
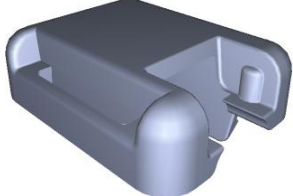

COMPONENT			SPARE PART																														
Code	Description	Image	Code	Description	Components list																												
VL1037A	WASHING SYSTEM ROTOR		KVL1037A	WASHING SYSTEM ROTOR KIT	<table border="1"> <thead> <tr> <th>Code</th> <th>Description</th> <th>Qty</th> <th>UOM</th> </tr> </thead> <tbody> <tr> <td>UG1005B1</td> <td>LONG RAY ROTOR WATER NOZZL</td> <td>1</td> <td>PZ</td> </tr> <tr> <td>UG1006B3</td> <td>LONG RAY ROTOR WATER NOZZL</td> <td>1</td> <td>PZ</td> </tr> <tr> <td>VI1220A1</td> <td>4,2X12 TCB SELF-TAPPIN G SCREW</td> <td>6</td> <td>PZ</td> </tr> <tr> <td>VM1955C0</td> <td>WASHING SYSTEM ROTOR</td> <td>1</td> <td>PZ</td> </tr> <tr> <td>VM1985C1</td> <td>WASHING SYSTEM ROTOR COVE</td> <td>1</td> <td>PZ</td> </tr> <tr> <td>VM1986A0</td> <td>NOZZLE COVE</td> <td>1</td> <td>PZ</td> </tr> </tbody> </table>	Code	Description	Qty	UOM	UG1005B1	LONG RAY ROTOR WATER NOZZL	1	PZ	UG1006B3	LONG RAY ROTOR WATER NOZZL	1	PZ	VI1220A1	4,2X12 TCB SELF-TAPPIN G SCREW	6	PZ	VM1955C0	WASHING SYSTEM ROTOR	1	PZ	VM1985C1	WASHING SYSTEM ROTOR COVE	1	PZ	VM1986A0	NOZZLE COVE	1	PZ
Code	Description	Qty	UOM																														
UG1005B1	LONG RAY ROTOR WATER NOZZL	1	PZ																														
UG1006B3	LONG RAY ROTOR WATER NOZZL	1	PZ																														
VI1220A1	4,2X12 TCB SELF-TAPPIN G SCREW	6	PZ																														
VM1955C0	WASHING SYSTEM ROTOR	1	PZ																														
VM1985C1	WASHING SYSTEM ROTOR COVE	1	PZ																														
VM1986A0	NOZZLE COVE	1	PZ																														
0H2551A	XBC/XVC ST.STEEL DRAIN COVER		0H2551A0	XBC/XVC ST.STEEL DRAIN COVER																													
0H7320A	6 S. VENTURI PIPE SUPPORT		0H7320A0	6 S. VENTURI PIPE SUPPORT																													
GN1563A	0511 DOOR GASKET		KGN1563A	0511 DOOR GASKET KIT	<table border="1"> <thead> <tr> <th>Code</th> <th>Description</th> <th>Qty</th> <th>UOM</th> </tr> </thead> <tbody> <tr> <td>GN1006A1</td> <td>DOOR GASKE</td> <td>2.240</td> <td>M</td> </tr> <tr> <td>GN1008A0</td> <td>DOOR SEAL INTERNAL CONNECTION</td> <td>0.030</td> <td>M</td> </tr> <tr> <td>SL1025A0</td> <td>CLEAR SILICON DOW CORNING 734</td> <td>0.012</td> <td>PZ</td> </tr> <tr> <td>VM2277A0</td> <td>DOOR SEAL KIT INTERNAL CONNECTION</td> <td>1</td> <td>PZ</td> </tr> </tbody> </table>	Code	Description	Qty	UOM	GN1006A1	DOOR GASKE	2.240	M	GN1008A0	DOOR SEAL INTERNAL CONNECTION	0.030	M	SL1025A0	CLEAR SILICON DOW CORNING 734	0.012	PZ	VM2277A0	DOOR SEAL KIT INTERNAL CONNECTION	1	PZ								
Code	Description	Qty	UOM																														
GN1006A1	DOOR GASKE	2.240	M																														
GN1008A0	DOOR SEAL INTERNAL CONNECTION	0.030	M																														
SL1025A0	CLEAR SILICON DOW CORNING 734	0.012	PZ																														
VM2277A0	DOOR SEAL KIT INTERNAL CONNECTION	1	PZ																														

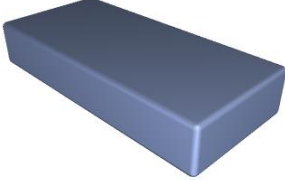



COMPONENT			SPARE PART																		
Code	Description	Image	Code	Description	Components list																
VM1820A	LATERAL SUPPORTS M6 FIXING BOLTS		KVM1820A	S.5 CHROMIUM PL. THUB SCREWS 10PCS KIT	<table border="1"> <thead> <tr> <th>Code</th> <th>Description</th> <th>Qty</th> <th>UOM</th> </tr> </thead> <tbody> <tr> <td>VM1820A0</td> <td>LATERAL SUPPORTS M6 FIXING BOLTS</td> <td>10</td> <td>PZ</td> </tr> </tbody> </table>	Code	Description	Qty	UOM	VM1820A0	LATERAL SUPPORTS M6 FIXING BOLTS	10	PZ								
Code	Description	Qty	UOM																		
VM1820A0	LATERAL SUPPORTS M6 FIXING BOLTS	10	PZ																		
OG1558A	FAN GUARD SPACE		KOG1558A	SPACER FAN GUARD KIT	<table border="1"> <thead> <tr> <th>Code</th> <th>Description</th> <th>Qty</th> <th>UOM</th> </tr> </thead> <tbody> <tr> <td>OG1558A0</td> <td>FAN GUARD SPACER</td> <td>1</td> <td>PZ</td> </tr> <tr> <td>IP1508A1</td> <td></td> <td>1.400</td> <td>M</td> </tr> <tr> <td>VM1059A1</td> <td></td> <td>1.500</td> <td>M</td> </tr> </tbody> </table>	Code	Description	Qty	UOM	OG1558A0	FAN GUARD SPACER	1	PZ	IP1508A1		1.400	M	VM1059A1		1.500	M
Code	Description	Qty	UOM																		
OG1558A0	FAN GUARD SPACER	1	PZ																		
IP1508A1		1.400	M																		
VM1059A1		1.500	M																		
RC1170A	STAINLESS STEEL NUT M14 H=8 CH=22		KRC1170A	M14 H8 CH22 NUT - 10 PCS. KIT	<table border="1"> <thead> <tr> <th>Code</th> <th>Description</th> <th>Qty</th> <th>UOM</th> </tr> </thead> <tbody> <tr> <td>RC1170A1</td> <td>STAINLESS STEEL NUT M14 H=8 CH=2</td> <td>10</td> <td>PZ</td> </tr> </tbody> </table>	Code	Description	Qty	UOM	RC1170A1	STAINLESS STEEL NUT M14 H=8 CH=2	10	PZ								
Code	Description	Qty	UOM																		
RC1170A1	STAINLESS STEEL NUT M14 H=8 CH=2	10	PZ																		
ASM1748A	General overview		ASM1748A0	General overview																	
VM2344A	ANTISCALE MAGNET HOLDER HALF COVER		KVM2344A	ANTI-LIMESCALE MAGNET HALF BEARING KIT	<table border="1"> <thead> <tr> <th>Code</th> <th>Description</th> <th>Qty</th> <th>UOM</th> </tr> </thead> <tbody> <tr> <td>VM2344A0</td> <td>ANTISCALE MAGNET HOLDER HALF COVER</td> <td>2</td> <td>PZ</td> </tr> </tbody> </table>	Code	Description	Qty	UOM	VM2344A0	ANTISCALE MAGNET HOLDER HALF COVER	2	PZ								
Code	Description	Qty	UOM																		
VM2344A0	ANTISCALE MAGNET HOLDER HALF COVER	2	PZ																		



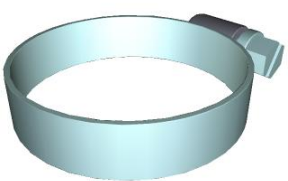

COMPONENT			SPARE PART										
Code	Description	Image	Code	Description	Components list								
VL1086A	LIMESCALE REMOVER NEODYMIUM MAGNET		KVL1086A	NEODYMIUM MAGNET ANTI-LIMESCALE KI	<table border="1"> <thead> <tr> <th>Code</th> <th>Description</th> <th>Qty</th> <th>UOM</th> </tr> </thead> <tbody> <tr> <td>VL1086A0</td> <td>LIMESCALE REMOVER NEODYMIUM MAGNET</td> <td>2</td> <td>PZ</td> </tr> </tbody> </table>	Code	Description	Qty	UOM	VL1086A0	LIMESCALE REMOVER NEODYMIUM MAGNET	2	PZ
Code	Description	Qty	UOM										
VL1086A0	LIMESCALE REMOVER NEODYMIUM MAGNET	2	PZ										
EL1361A	D8-D10 THREE-STAGE WATER SOLENOID VALVE		KEL1361A	XBC/XVC WATER SOLENOID VALVE KI	<table border="1"> <thead> <tr> <th>Code</th> <th>Description</th> <th>Qty</th> <th>UOM</th> </tr> </thead> <tbody> <tr> <td>EL1361A0</td> <td>D8-D10 THREE-STAGE WATER SOLENOID VALVE</td> <td>1</td> <td>PZ</td> </tr> </tbody> </table>	Code	Description	Qty	UOM	EL1361A0	D8-D10 THREE-STAGE WATER SOLENOID VALVE	1	PZ
Code	Description	Qty	UOM										
EL1361A0	D8-D10 THREE-STAGE WATER SOLENOID VALVE	1	PZ										
TB2935A			TB2935A0										
VM2331A	FAN GUARD-TRAYS HOLDER PIN		KVM2331A	KIT FAN GUARD-TRAYS HOLDER PIN	<table border="1"> <thead> <tr> <th>Code</th> <th>Description</th> <th>Qty</th> <th>UOM</th> </tr> </thead> <tbody> <tr> <td>VM2331A0</td> <td>FAN GUARD-TRAY S HOLDER PIN</td> <td>4</td> <td>PZ</td> </tr> </tbody> </table>	Code	Description	Qty	UOM	VM2331A0	FAN GUARD-TRAY S HOLDER PIN	4	PZ
Code	Description	Qty	UOM										
VM2331A0	FAN GUARD-TRAY S HOLDER PIN	4	PZ										
GN1085A	141X24 HEATING ELEMENT GASKET		KGN1085A	HEATING ELEMENT GASKET KIT	<table border="1"> <thead> <tr> <th>Code</th> <th>Description</th> <th>Qty</th> <th>UOM</th> </tr> </thead> <tbody> <tr> <td>GN1085A2</td> <td>141X24 HEATING ELEMENT GASKET</td> <td>1</td> <td>PZ</td> </tr> </tbody> </table>	Code	Description	Qty	UOM	GN1085A2	141X24 HEATING ELEMENT GASKET	1	PZ
Code	Description	Qty	UOM										
GN1085A2	141X24 HEATING ELEMENT GASKET	1	PZ										

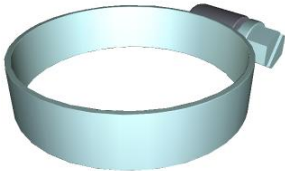
COMPONENT			SPARE PART																																														
Code	Description	Image	Code	Description	Components list																																												
RS1002A	6750W 230V D230 6 TURNS HEATING ELEMENT		KRS1002A	6750W 230V HEATING ELEMENT KIT	<table border="1"> <thead> <tr> <th>Code</th> <th>Description</th> <th>Qty</th> <th>UOM</th> </tr> </thead> <tbody> <tr> <td>GN1086A0</td> <td>ELEMENT SEALING</td> <td>1</td> <td>PZ</td> </tr> <tr> <td>RS1002A1</td> <td>6750W 230V D230 6 TURNS HEATING ELEMENT</td> <td>1</td> <td>PZ</td> </tr> <tr> <td>SL1045A0</td> <td>S53 BLACK SILICONE - 80ML CARTRIDGE</td> <td>1</td> <td>PZ</td> </tr> <tr> <td>VI1220A1</td> <td>4,2X12 TCB SELF-TAPPIN G SCREW</td> <td>5</td> <td>PZ</td> </tr> <tr> <td>VM1794A0</td> <td>250X4.8 PA66 BLACK CLAMP</td> <td>2</td> <td>PZ</td> </tr> <tr> <td>VM2103A0</td> <td>CLAMP LOCK</td> <td>2</td> <td>PZ</td> </tr> </tbody> </table>	Code	Description	Qty	UOM	GN1086A0	ELEMENT SEALING	1	PZ	RS1002A1	6750W 230V D230 6 TURNS HEATING ELEMENT	1	PZ	SL1045A0	S53 BLACK SILICONE - 80ML CARTRIDGE	1	PZ	VI1220A1	4,2X12 TCB SELF-TAPPIN G SCREW	5	PZ	VM1794A0	250X4.8 PA66 BLACK CLAMP	2	PZ	VM2103A0	CLAMP LOCK	2	PZ																
					Code	Description	Qty	UOM																																									
					GN1086A0	ELEMENT SEALING	1	PZ																																									
					RS1002A1	6750W 230V D230 6 TURNS HEATING ELEMENT	1	PZ																																									
					SL1045A0	S53 BLACK SILICONE - 80ML CARTRIDGE	1	PZ																																									
					VI1220A1	4,2X12 TCB SELF-TAPPIN G SCREW	5	PZ																																									
					VM1794A0	250X4.8 PA66 BLACK CLAMP	2	PZ																																									
VM2103A0	CLAMP LOCK	2	PZ																																														
0H2730A	ZINC PLATED MUFFLE SUPPORT BRACKET		0H2730A1	ZINC PLATED MUFFLE SUPPORT BRACKET																																													
RC1378A	HOSE CLAMP		KVE1135A	SERIES 5/5E VENTURI KIT	<table border="1"> <thead> <tr> <th>Code</th> <th>Description</th> <th>Qty</th> <th>UOM</th> </tr> </thead> <tbody> <tr> <td>GN1310A0</td> <td>VENTURI PIPE SEAL</td> <td>1</td> <td>PZ</td> </tr> <tr> <td>GN1556A0</td> <td>MM VENTURI SEAL</td> <td>1</td> <td>PZ</td> </tr> <tr> <td>RC1378A0</td> <td>HOSE CLAMP</td> <td>2</td> <td>PZ</td> </tr> <tr> <td>TB1520A0</td> <td>INT. Ø=38 TH=4 DRAIN BLACK RUBBER PIPE</td> <td>0.050</td> <td>M</td> </tr> <tr> <td>VE1135A0</td> <td>220 V 50/60 HZ VENTURI ACTUATOR</td> <td>1</td> <td>PZ</td> </tr> <tr> <td>VI1032A0</td> <td>ENG-VITE M4X16 TCB+ INOX A2 DIN 7985</td> <td>1</td> <td>PZ</td> </tr> <tr> <td>VI1511A0</td> <td>ENG-RONDEL LA D.4X12 INO</td> <td>2</td> <td>PZ</td> </tr> <tr> <td>VI1850A0</td> <td>M4X6 NICKEL PLATED FIXING SCRE</td> <td>2</td> <td>PZ</td> </tr> <tr> <td>VI1865A0</td> <td>5X10 TCB+ SELF-THREADI NG SCREW</td> <td>3</td> <td>PZ</td> </tr> <tr> <td>VM1565B0</td> <td>VENTURI LOWER COIL SUPPORT</td> <td>1</td> <td>PZ</td> </tr> </tbody> </table>	Code	Description	Qty	UOM	GN1310A0	VENTURI PIPE SEAL	1	PZ	GN1556A0	MM VENTURI SEAL	1	PZ	RC1378A0	HOSE CLAMP	2	PZ	TB1520A0	INT. Ø=38 TH=4 DRAIN BLACK RUBBER PIPE	0.050	M	VE1135A0	220 V 50/60 HZ VENTURI ACTUATOR	1	PZ	VI1032A0	ENG-VITE M4X16 TCB+ INOX A2 DIN 7985	1	PZ	VI1511A0	ENG-RONDEL LA D.4X12 INO	2	PZ	VI1850A0	M4X6 NICKEL PLATED FIXING SCRE	2	PZ	VI1865A0	5X10 TCB+ SELF-THREADI NG SCREW	3	PZ	VM1565B0	VENTURI LOWER COIL SUPPORT	1	PZ
					Code	Description	Qty	UOM																																									
					GN1310A0	VENTURI PIPE SEAL	1	PZ																																									
					GN1556A0	MM VENTURI SEAL	1	PZ																																									
					RC1378A0	HOSE CLAMP	2	PZ																																									
					TB1520A0	INT. Ø=38 TH=4 DRAIN BLACK RUBBER PIPE	0.050	M																																									
					VE1135A0	220 V 50/60 HZ VENTURI ACTUATOR	1	PZ																																									
					VI1032A0	ENG-VITE M4X16 TCB+ INOX A2 DIN 7985	1	PZ																																									
					VI1511A0	ENG-RONDEL LA D.4X12 INO	2	PZ																																									
					VI1850A0	M4X6 NICKEL PLATED FIXING SCRE	2	PZ																																									
					VI1865A0	5X10 TCB+ SELF-THREADI NG SCREW	3	PZ																																									
					VM1565B0	VENTURI LOWER COIL SUPPORT	1	PZ																																									





COMPONENT			SPARE PART																																																		
Code	Description	Image	Code	Description	Components list																																																
RC1378A	HOSE CLAMP		KVE1135A	SERIES 5/5E VENTURI KIT	<table border="1"> <thead> <tr> <th>Code</th> <th>Description</th> <th>Qty</th> <th>UOM</th> </tr> </thead> <tbody> <tr> <td>VM1566A0</td> <td>VENTURI UPPER COIL SUPPORT</td> <td>1</td> <td>PZ</td> </tr> <tr> <td>VM1567A0</td> <td>VENTURI LOWER BUSHING</td> <td>1</td> <td>PZ</td> </tr> <tr> <td>VM1568A0</td> <td>VENTURI PLATE SPACE</td> <td>1</td> <td>PZ</td> </tr> </tbody> </table>	Code	Description	Qty	UOM	VM1566A0	VENTURI UPPER COIL SUPPORT	1	PZ	VM1567A0	VENTURI LOWER BUSHING	1	PZ	VM1568A0	VENTURI PLATE SPACE	1	PZ																																
Code	Description	Qty	UOM																																																		
VM1566A0	VENTURI UPPER COIL SUPPORT	1	PZ																																																		
VM1567A0	VENTURI LOWER BUSHING	1	PZ																																																		
VM1568A0	VENTURI PLATE SPACE	1	PZ																																																		
VM2377A			KVM2377A	MM OVENS VENTURI 220V 50/60HZ KIT	<table border="1"> <thead> <tr> <th>Code</th> <th>Description</th> <th>Qty</th> <th>UOM</th> </tr> </thead> <tbody> <tr> <td>GN1556A0</td> <td>MM VENTURI SEAL</td> <td>1</td> <td>PZ</td> </tr> <tr> <td>RC1378A0</td> <td>HOSE CLAMP</td> <td>3</td> <td>PZ</td> </tr> <tr> <td>TB1520A0</td> <td>INT. Ø=38 TH=4 DRAIN BLACK RUBBER PIPE</td> <td>0.170</td> <td>M</td> </tr> <tr> <td>VE1135A0</td> <td>220 V 50/60 HZ VENTURI ACTUATOR</td> <td>1</td> <td>PZ</td> </tr> <tr> <td>VI1032A0</td> <td>ENG-VITE M4X16 TCB+ INOX A2 DIN 7985</td> <td>1</td> <td>PZ</td> </tr> <tr> <td>VI1220A1</td> <td>4,2X12 TCB SELF-TAPPIN G SCREW</td> <td>6</td> <td>PZ</td> </tr> <tr> <td>VM2345A0</td> <td>MM VENTURI UPPER HALF</td> <td>1</td> <td>PZ</td> </tr> <tr> <td>VM2346A0</td> <td>MM VENTURI LOWER HALF</td> <td>1</td> <td>PZ</td> </tr> <tr> <td>VM2347A0</td> <td>MIND.MAPS VENTURI COVER</td> <td>1</td> <td>PZ</td> </tr> <tr> <td>VM2348A0</td> <td>VENTURI PLATE SPACE</td> <td>1</td> <td>PZ</td> </tr> <tr> <td>VM2349A0</td> <td>VENTURI LOWER BUSHING</td> <td>1</td> <td>PZ</td> </tr> </tbody> </table>	Code	Description	Qty	UOM	GN1556A0	MM VENTURI SEAL	1	PZ	RC1378A0	HOSE CLAMP	3	PZ	TB1520A0	INT. Ø=38 TH=4 DRAIN BLACK RUBBER PIPE	0.170	M	VE1135A0	220 V 50/60 HZ VENTURI ACTUATOR	1	PZ	VI1032A0	ENG-VITE M4X16 TCB+ INOX A2 DIN 7985	1	PZ	VI1220A1	4,2X12 TCB SELF-TAPPIN G SCREW	6	PZ	VM2345A0	MM VENTURI UPPER HALF	1	PZ	VM2346A0	MM VENTURI LOWER HALF	1	PZ	VM2347A0	MIND.MAPS VENTURI COVER	1	PZ	VM2348A0	VENTURI PLATE SPACE	1	PZ	VM2349A0	VENTURI LOWER BUSHING	1	PZ
Code	Description	Qty	UOM																																																		
GN1556A0	MM VENTURI SEAL	1	PZ																																																		
RC1378A0	HOSE CLAMP	3	PZ																																																		
TB1520A0	INT. Ø=38 TH=4 DRAIN BLACK RUBBER PIPE	0.170	M																																																		
VE1135A0	220 V 50/60 HZ VENTURI ACTUATOR	1	PZ																																																		
VI1032A0	ENG-VITE M4X16 TCB+ INOX A2 DIN 7985	1	PZ																																																		
VI1220A1	4,2X12 TCB SELF-TAPPIN G SCREW	6	PZ																																																		
VM2345A0	MM VENTURI UPPER HALF	1	PZ																																																		
VM2346A0	MM VENTURI LOWER HALF	1	PZ																																																		
VM2347A0	MIND.MAPS VENTURI COVER	1	PZ																																																		
VM2348A0	VENTURI PLATE SPACE	1	PZ																																																		
VM2349A0	VENTURI LOWER BUSHING	1	PZ																																																		
GN1584A	CORNER FITTING D30-D16		KG1584A	D30-D16 CORNER FITTING KIT	<table border="1"> <thead> <tr> <th>Code</th> <th>Description</th> <th>Qty</th> <th>UOM</th> </tr> </thead> <tbody> <tr> <td>GN1584A0</td> <td>CORNER FITTING D30-D16</td> <td>1</td> <td>PZ</td> </tr> </tbody> </table>	Code	Description	Qty	UOM	GN1584A0	CORNER FITTING D30-D16	1	PZ																																								
Code	Description	Qty	UOM																																																		
GN1584A0	CORNER FITTING D30-D16	1	PZ																																																		



COMPONENT			SPARE PART																																																										
Code	Description	Image	Code	Description	Components list																																																								
TB1956A			KVE1135A	SERIES 5/5E VENTURI KIT	<table border="1"> <thead> <tr> <th>Code</th> <th>Description</th> <th>Qty</th> <th>UOM</th> </tr> </thead> <tbody> <tr> <td>GN1310A0</td> <td>VENTURI PIPE SEAL</td> <td>1</td> <td>PZ</td> </tr> <tr> <td>GN1556A0</td> <td>MM VENTURI SEAL</td> <td>1</td> <td>PZ</td> </tr> <tr> <td>RC1378A0</td> <td>HOSE CLAMP</td> <td>2</td> <td>PZ</td> </tr> <tr> <td>TB1520A0</td> <td>INT. Ø=38 TH=4 DRAIN BLACK RUBBER PIPE</td> <td>0.050</td> <td>M</td> </tr> <tr> <td>VE1135A0</td> <td>220 V 50/60 HZ VENTURI ACTUATOR</td> <td>1</td> <td>PZ</td> </tr> <tr> <td>VI1032A0</td> <td>ENG-VITE M4X16 TCB+ INOX A2 DIN 7985</td> <td>1</td> <td>PZ</td> </tr> <tr> <td>VI1511A0</td> <td>ENG-RONDEL LA D.4X12 INO</td> <td>2</td> <td>PZ</td> </tr> <tr> <td>VI1850A0</td> <td>M4X6 NICKEL PLATED FIXING SCRE</td> <td>2</td> <td>PZ</td> </tr> <tr> <td>VI1865A0</td> <td>5X10 TCB+ SELF-THREADI NG SCREW</td> <td>3</td> <td>PZ</td> </tr> <tr> <td>VM1565B0</td> <td>VENTURI LOWER COIL SUPPORT</td> <td>1</td> <td>PZ</td> </tr> <tr> <td>VM1566A0</td> <td>VENTURI UPPER COIL SUPPORT</td> <td>1</td> <td>PZ</td> </tr> <tr> <td>VM1567A0</td> <td>VENTURI LOWER BUSHING</td> <td>1</td> <td>PZ</td> </tr> <tr> <td>VM1568A0</td> <td>VENTURI PLATE SPACE</td> <td>1</td> <td>PZ</td> </tr> </tbody> </table>	Code	Description	Qty	UOM	GN1310A0	VENTURI PIPE SEAL	1	PZ	GN1556A0	MM VENTURI SEAL	1	PZ	RC1378A0	HOSE CLAMP	2	PZ	TB1520A0	INT. Ø=38 TH=4 DRAIN BLACK RUBBER PIPE	0.050	M	VE1135A0	220 V 50/60 HZ VENTURI ACTUATOR	1	PZ	VI1032A0	ENG-VITE M4X16 TCB+ INOX A2 DIN 7985	1	PZ	VI1511A0	ENG-RONDEL LA D.4X12 INO	2	PZ	VI1850A0	M4X6 NICKEL PLATED FIXING SCRE	2	PZ	VI1865A0	5X10 TCB+ SELF-THREADI NG SCREW	3	PZ	VM1565B0	VENTURI LOWER COIL SUPPORT	1	PZ	VM1566A0	VENTURI UPPER COIL SUPPORT	1	PZ	VM1567A0	VENTURI LOWER BUSHING	1	PZ	VM1568A0	VENTURI PLATE SPACE	1	PZ
					Code	Description	Qty	UOM																																																					
					GN1310A0	VENTURI PIPE SEAL	1	PZ																																																					
					GN1556A0	MM VENTURI SEAL	1	PZ																																																					
					RC1378A0	HOSE CLAMP	2	PZ																																																					
					TB1520A0	INT. Ø=38 TH=4 DRAIN BLACK RUBBER PIPE	0.050	M																																																					
					VE1135A0	220 V 50/60 HZ VENTURI ACTUATOR	1	PZ																																																					
					VI1032A0	ENG-VITE M4X16 TCB+ INOX A2 DIN 7985	1	PZ																																																					
					VI1511A0	ENG-RONDEL LA D.4X12 INO	2	PZ																																																					
					VI1850A0	M4X6 NICKEL PLATED FIXING SCRE	2	PZ																																																					
					VI1865A0	5X10 TCB+ SELF-THREADI NG SCREW	3	PZ																																																					
					VM1565B0	VENTURI LOWER COIL SUPPORT	1	PZ																																																					
					VM1566A0	VENTURI UPPER COIL SUPPORT	1	PZ																																																					
VM1567A0	VENTURI LOWER BUSHING	1	PZ																																																										
VM1568A0	VENTURI PLATE SPACE	1	PZ																																																										
RC1042A	DOUBLE WIRE SPRING CLAMP D21.5-22.6		RC1042A0	DOUBLE WIRE SPRING CLAMP D21.5-22.6																																																									

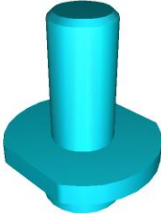

COMPONENT			SPARE PART																										
Code	Description	Image	Code	Description	Components list																								
TB2957B			KTB2957B	XEVC-0511-E VENTURI PIPE KIT	<table border="1"> <thead> <tr> <th>Code</th> <th>Description</th> <th>Qty</th> <th>UOM</th> </tr> </thead> <tbody> <tr> <td>GN1544A0</td> <td>AIR INLET GASKET</td> <td>1</td> <td>PZ</td> </tr> <tr> <td>GN1584A0</td> <td>CORNER FITTING D30-D16</td> <td>1</td> <td>PZ</td> </tr> <tr> <td>RC1042A0</td> <td>DOUBLE WIRE SPRING CLAMP D21.5-22.6</td> <td>1</td> <td>PZ</td> </tr> <tr> <td>TB2957B0</td> <td></td> <td>1</td> <td>PZ</td> </tr> <tr> <td>VM1794A0</td> <td>250X4.8 PA66 BLACK CLAMP</td> <td>1</td> <td>PZ</td> </tr> </tbody> </table>	Code	Description	Qty	UOM	GN1544A0	AIR INLET GASKET	1	PZ	GN1584A0	CORNER FITTING D30-D16	1	PZ	RC1042A0	DOUBLE WIRE SPRING CLAMP D21.5-22.6	1	PZ	TB2957B0		1	PZ	VM1794A0	250X4.8 PA66 BLACK CLAMP	1	PZ
Code	Description	Qty	UOM																										
GN1544A0	AIR INLET GASKET	1	PZ																										
GN1584A0	CORNER FITTING D30-D16	1	PZ																										
RC1042A0	DOUBLE WIRE SPRING CLAMP D21.5-22.6	1	PZ																										
TB2957B0		1	PZ																										
VM1794A0	250X4.8 PA66 BLACK CLAMP	1	PZ																										
GN1588A			GN1588A0																										
VM2416A			VM2416A0																										

**ASM2916A/0.D00 - External cover**

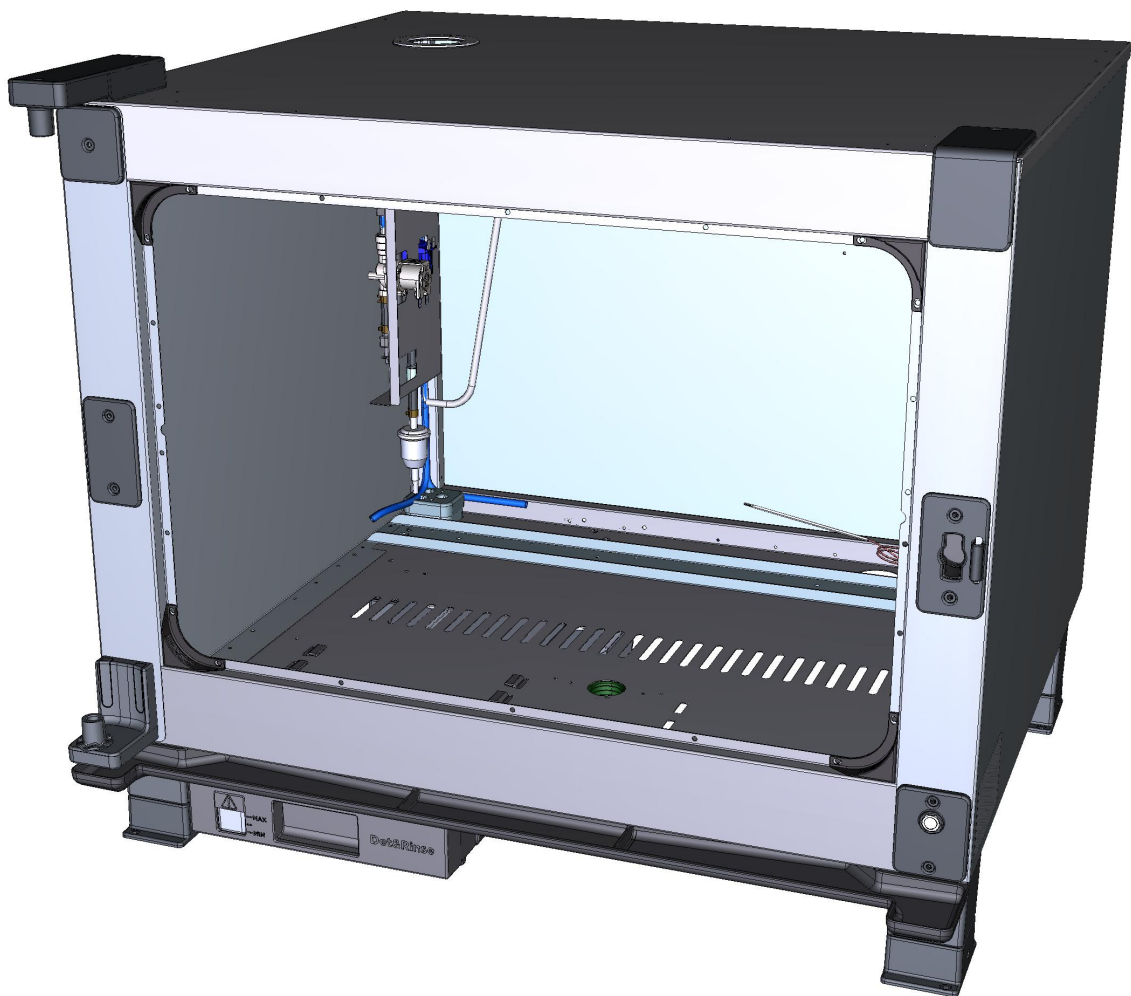

**FRONT**

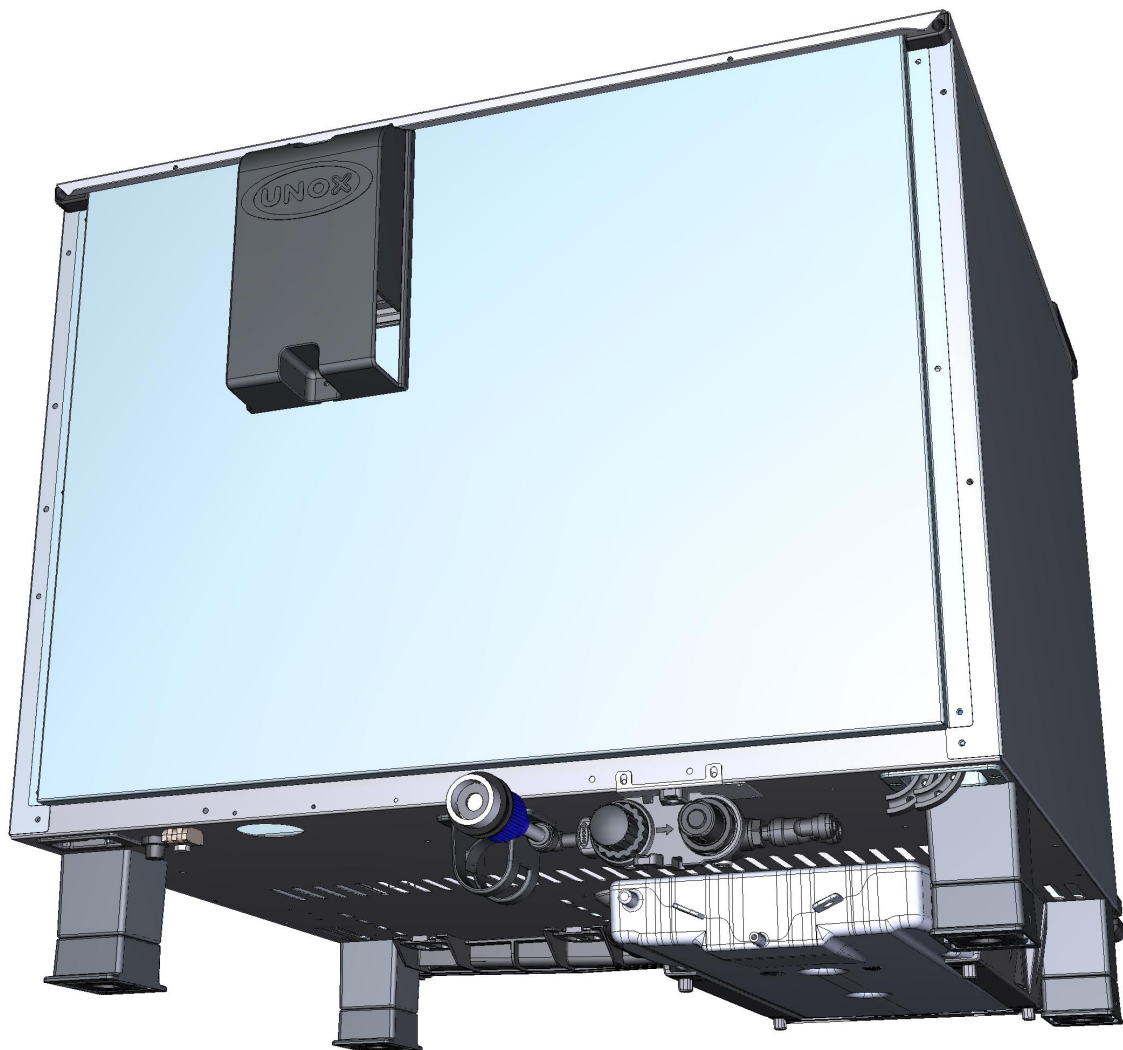

ASM2916A/0.D00 - External cover

REAR

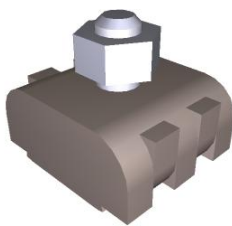

COMPONENT			SPARE PART																										
Code	Description	Image	Code	Description	Components list																								
TR1136A	330°C 1 POLE SAFETY THERMOSTAT		KTR1136A	SAFETY UNIP.THERMOSTAT KIT	<table border="1"> <thead> <tr> <th>Code</th> <th>Description</th> <th>Qty</th> <th>UOM</th> </tr> </thead> <tbody> <tr> <td>0H7030A0</td> <td>THERMOSTAT BULB INLET COVER</td> <td>1</td> <td>PZ</td> </tr> <tr> <td>GN1531A0</td> <td>THERMOSTAT BULB INLET SEALING</td> <td>1</td> <td>PZ</td> </tr> <tr> <td>SL1045A0</td> <td>S53 BLACK SILICONE - 80ML CARTRIDGE</td> <td>1</td> <td>PZ</td> </tr> <tr> <td>TR1136A0</td> <td>330°C 1 POLE SAFETY THERMOSTAT</td> <td>1</td> <td>PZ</td> </tr> <tr> <td>VI1220A1</td> <td>4,2X12 TCB SELF-TAPPIN G SCREW</td> <td>3</td> <td>PZ</td> </tr> </tbody> </table>	Code	Description	Qty	UOM	0H7030A0	THERMOSTAT BULB INLET COVER	1	PZ	GN1531A0	THERMOSTAT BULB INLET SEALING	1	PZ	SL1045A0	S53 BLACK SILICONE - 80ML CARTRIDGE	1	PZ	TR1136A0	330°C 1 POLE SAFETY THERMOSTAT	1	PZ	VI1220A1	4,2X12 TCB SELF-TAPPIN G SCREW	3	PZ
Code	Description	Qty	UOM																										
0H7030A0	THERMOSTAT BULB INLET COVER	1	PZ																										
GN1531A0	THERMOSTAT BULB INLET SEALING	1	PZ																										
SL1045A0	S53 BLACK SILICONE - 80ML CARTRIDGE	1	PZ																										
TR1136A0	330°C 1 POLE SAFETY THERMOSTAT	1	PZ																										
VI1220A1	4,2X12 TCB SELF-TAPPIN G SCREW	3	PZ																										
VM1750A	BRASS COMB CLAM		KVM1750A	COMB TERMINAL BLOCK KIT	<table border="1"> <thead> <tr> <th>Code</th> <th>Description</th> <th>Qty</th> <th>UOM</th> </tr> </thead> <tbody> <tr> <td>VM1750A0</td> <td>BRASS COMB CLAMP</td> <td>1</td> <td>PZ</td> </tr> </tbody> </table>	Code	Description	Qty	UOM	VM1750A0	BRASS COMB CLAMP	1	PZ																
Code	Description	Qty	UOM																										
VM1750A0	BRASS COMB CLAMP	1	PZ																										
VM2074A	DRIP TRAY FIXING CLIP WITH SCREW		KVM1220A	CT/BT DRIP TRAY FIXING CLIPS 4PCS KIT	<table border="1"> <thead> <tr> <th>Code</th> <th>Description</th> <th>Qty</th> <th>UOM</th> </tr> </thead> <tbody> <tr> <td>VI1220A1</td> <td>4,2X12 TCB SELF-TAPPIN G SCREW</td> <td>4</td> <td>PZ</td> </tr> <tr> <td>VM1220A0</td> <td>CLIP TO FIX DRIP TRAY C.T</td> <td>4</td> <td>PZ</td> </tr> <tr> <td>VM2074A0</td> <td>DRIP TRAY FIXING CLIP WITH SCREW</td> <td>4</td> <td>PZ</td> </tr> </tbody> </table>	Code	Description	Qty	UOM	VI1220A1	4,2X12 TCB SELF-TAPPIN G SCREW	4	PZ	VM1220A0	CLIP TO FIX DRIP TRAY C.T	4	PZ	VM2074A0	DRIP TRAY FIXING CLIP WITH SCREW	4	PZ								
Code	Description	Qty	UOM																										
VI1220A1	4,2X12 TCB SELF-TAPPIN G SCREW	4	PZ																										
VM1220A0	CLIP TO FIX DRIP TRAY C.T	4	PZ																										
VM2074A0	DRIP TRAY FIXING CLIP WITH SCREW	4	PZ																										
VN1165A	230VAC 50/60HZ COOLING DOWN FA		KVN1165A	230V 120X120 MOTOR FAN KIT	<table border="1"> <thead> <tr> <th>Code</th> <th>Description</th> <th>Qty</th> <th>UOM</th> </tr> </thead> <tbody> <tr> <td>VI1099A0</td> <td></td> <td>4</td> <td>PZ</td> </tr> <tr> <td>VM1555A2</td> <td>CT BT COOLING FAN SUPPORT</td> <td>1</td> <td>PZ</td> </tr> <tr> <td>VN1165A0</td> <td>230VAC 50/60HZ COOLING DOWN FAN</td> <td>1</td> <td>PZ</td> </tr> </tbody> </table>	Code	Description	Qty	UOM	VI1099A0		4	PZ	VM1555A2	CT BT COOLING FAN SUPPORT	1	PZ	VN1165A0	230VAC 50/60HZ COOLING DOWN FAN	1	PZ								
Code	Description	Qty	UOM																										
VI1099A0		4	PZ																										
VM1555A2	CT BT COOLING FAN SUPPORT	1	PZ																										
VN1165A0	230VAC 50/60HZ COOLING DOWN FAN	1	PZ																										



COMPONENT			SPARE PART																																		
Code	Description	Image	Code	Description	Components list																																
VM1556A	XBC-XVC COOLING FAN GUARD		KVM1556A	XBC-XVC COOLING FAN GUARD KIT	<table border="1"> <thead> <tr> <th>Code</th> <th>Description</th> <th>Qty</th> <th>UOM</th> </tr> </thead> <tbody> <tr> <td>VM1556A0</td> <td>XBC-XVC COOLING FAN GUARD</td> <td>1</td> <td>PZ</td> </tr> </tbody> </table>	Code	Description	Qty	UOM	VM1556A0	XBC-XVC COOLING FAN GUARD	1	PZ																								
Code	Description	Qty	UOM																																		
VM1556A0	XBC-XVC COOLING FAN GUARD	1	PZ																																		
VM1555A	CT BT COOLING FAN SUPPORT		<p>KVN1165A</p> <p>KVN1164A</p>	<p>230V 120X120 MOTOR FAN KIT</p> <p>12VDC COOLING DOWN FAN KIT</p>	<table border="1"> <thead> <tr> <th>Code</th> <th>Description</th> <th>Qty</th> <th>UOM</th> </tr> </thead> <tbody> <tr> <td>VI1099A0</td> <td></td> <td>4</td> <td>PZ</td> </tr> <tr> <td>VM1555A2</td> <td>CT BT COOLING FAN SUPPORT</td> <td>1</td> <td>PZ</td> </tr> <tr> <td>VN1165A0</td> <td>230VAC 50/60HZ COOLING DOWN FAN</td> <td>1</td> <td>PZ</td> </tr> </tbody> </table> <table border="1"> <thead> <tr> <th>Code</th> <th>Description</th> <th>Qty</th> <th>UOM</th> </tr> </thead> <tbody> <tr> <td>VI1099A0</td> <td></td> <td>4</td> <td>PZ</td> </tr> <tr> <td>VM1555A2</td> <td>CT BT COOLING FAN SUPPORT</td> <td>1</td> <td>PZ</td> </tr> <tr> <td>VN1164A0</td> <td>12VDC COOLING DOWN FAN</td> <td>1</td> <td>PZ</td> </tr> </tbody> </table>	Code	Description	Qty	UOM	VI1099A0		4	PZ	VM1555A2	CT BT COOLING FAN SUPPORT	1	PZ	VN1165A0	230VAC 50/60HZ COOLING DOWN FAN	1	PZ	Code	Description	Qty	UOM	VI1099A0		4	PZ	VM1555A2	CT BT COOLING FAN SUPPORT	1	PZ	VN1164A0	12VDC COOLING DOWN FAN	1	PZ
Code	Description	Qty	UOM																																		
VI1099A0		4	PZ																																		
VM1555A2	CT BT COOLING FAN SUPPORT	1	PZ																																		
VN1165A0	230VAC 50/60HZ COOLING DOWN FAN	1	PZ																																		
Code	Description	Qty	UOM																																		
VI1099A0		4	PZ																																		
VM1555A2	CT BT COOLING FAN SUPPORT	1	PZ																																		
VN1164A0	12VDC COOLING DOWN FAN	1	PZ																																		
0H1019A	BRACKET FOR CHEFTOP H100 FEE		0H1019A2	BRACKET FOR CHEFTOP H100 FEE																																	
PD1074A	H=100 SQUARE FOO		KPD1074A	MIND.MAPS H100 FOOT KIT	<table border="1"> <thead> <tr> <th>Code</th> <th>Description</th> <th>Qty</th> <th>UOM</th> </tr> </thead> <tbody> <tr> <td>PD1074A0</td> <td>H=100 SQUARE FOO</td> <td>1</td> <td>PZ</td> </tr> <tr> <td>PD1075A0</td> <td>FOOT LOCKING BRACKET</td> <td>1</td> <td>PZ</td> </tr> <tr> <td>VI1220A1</td> <td>4,2X12 TCB SELF-TAPPING SCREW</td> <td>5</td> <td>PZ</td> </tr> </tbody> </table>	Code	Description	Qty	UOM	PD1074A0	H=100 SQUARE FOO	1	PZ	PD1075A0	FOOT LOCKING BRACKET	1	PZ	VI1220A1	4,2X12 TCB SELF-TAPPING SCREW	5	PZ																
Code	Description	Qty	UOM																																		
PD1074A0	H=100 SQUARE FOO	1	PZ																																		
PD1075A0	FOOT LOCKING BRACKET	1	PZ																																		
VI1220A1	4,2X12 TCB SELF-TAPPING SCREW	5	PZ																																		

COMPONENT			SPARE PART																		
Code	Description	Image	Code	Description	Components list																
PD1075A	FOOT LOCKING BRACKET		KPD1075A	OVEN FOOT STOPPING BRACKET KIT	<table border="1"> <thead> <tr> <th>Code</th> <th>Description</th> <th>Qty</th> <th>UOM</th> </tr> </thead> <tbody> <tr> <td>PD1075A0</td> <td>FOOT LOCKING BRACKET</td> <td>4</td> <td>PZ</td> </tr> <tr> <td>VI1950A0</td> <td>ST. STEEL 4,2X13 TCB SELF-DRILLING SCREW</td> <td>8</td> <td>PZ</td> </tr> </tbody> </table>	Code	Description	Qty	UOM	PD1075A0	FOOT LOCKING BRACKET	4	PZ	VI1950A0	ST. STEEL 4,2X13 TCB SELF-DRILLING SCREW	8	PZ				
Code	Description	Qty	UOM																		
PD1075A0	FOOT LOCKING BRACKET	4	PZ																		
VI1950A0	ST. STEEL 4,2X13 TCB SELF-DRILLING SCREW	8	PZ																		
VL1026A	BEND FOR DRAIN PIPE		KVL1026A	DRAIN PIPE BEND KIT	<table border="1"> <thead> <tr> <th>Code</th> <th>Description</th> <th>Qty</th> <th>UOM</th> </tr> </thead> <tbody> <tr> <td>GN1400A0</td> <td>U-TRAP SEAL</td> <td>1</td> <td>PZ</td> </tr> <tr> <td>VL1026A0</td> <td>BEND FOR DRAIN PIPE</td> <td>1</td> <td>PZ</td> </tr> <tr> <td>VM2039A0</td> <td>DRAIN BEND FIXING RING</td> <td>1</td> <td>PZ</td> </tr> </tbody> </table>	Code	Description	Qty	UOM	GN1400A0	U-TRAP SEAL	1	PZ	VL1026A0	BEND FOR DRAIN PIPE	1	PZ	VM2039A0	DRAIN BEND FIXING RING	1	PZ
Code	Description	Qty	UOM																		
GN1400A0	U-TRAP SEAL	1	PZ																		
VL1026A0	BEND FOR DRAIN PIPE	1	PZ																		
VM2039A0	DRAIN BEND FIXING RING	1	PZ																		
VM2039A	DRAIN BEND FIXING RING		KVL1026A	DRAIN PIPE BEND KIT	<table border="1"> <thead> <tr> <th>Code</th> <th>Description</th> <th>Qty</th> <th>UOM</th> </tr> </thead> <tbody> <tr> <td>GN1400A0</td> <td>U-TRAP SEAL</td> <td>1</td> <td>PZ</td> </tr> <tr> <td>VL1026A0</td> <td>BEND FOR DRAIN PIPE</td> <td>1</td> <td>PZ</td> </tr> <tr> <td>VM2039A0</td> <td>DRAIN BEND FIXING RING</td> <td>1</td> <td>PZ</td> </tr> </tbody> </table>	Code	Description	Qty	UOM	GN1400A0	U-TRAP SEAL	1	PZ	VL1026A0	BEND FOR DRAIN PIPE	1	PZ	VM2039A0	DRAIN BEND FIXING RING	1	PZ
Code	Description	Qty	UOM																		
GN1400A0	U-TRAP SEAL	1	PZ																		
VL1026A0	BEND FOR DRAIN PIPE	1	PZ																		
VM2039A0	DRAIN BEND FIXING RING	1	PZ																		
VM2249A	COOKING CHAMBER FRONT CORNER		KVM2249A	CHAMBER FRONT PROFILE CORNER KIT	<table border="1"> <thead> <tr> <th>Code</th> <th>Description</th> <th>Qty</th> <th>UOM</th> </tr> </thead> <tbody> <tr> <td>VM2249A0</td> <td>COOKING CHAMBER FRONT CORNER</td> <td>1</td> <td>PZ</td> </tr> </tbody> </table>	Code	Description	Qty	UOM	VM2249A0	COOKING CHAMBER FRONT CORNER	1	PZ								
Code	Description	Qty	UOM																		
VM2249A0	COOKING CHAMBER FRONT CORNER	1	PZ																		
0H2561A	6 S. DOOR COUNTERBRACKET		0H2561A0	6 S. DOOR COUNTERBRACKET																	





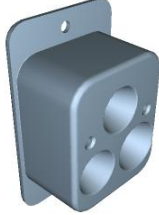
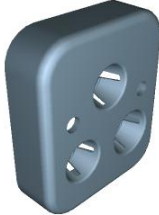

COMPONENT			SPARE PART										
Code	Description	Image	Code	Description	Components list								
VM1240A	NYLON SUPPORT CAP		KVM1240A	4 PCS COUNTER BRACKET SUPPORT CAP KIT	<table border="1"> <thead> <tr> <th>Code</th> <th>Description</th> <th>Qty</th> <th>UOM</th> </tr> </thead> <tbody> <tr> <td>VM1240A0</td> <td>NYLON SUPPORT CAP</td> <td>4</td> <td>PZ</td> </tr> </tbody> </table>	Code	Description	Qty	UOM	VM1240A0	NYLON SUPPORT CAP	4	PZ
Code	Description	Qty	UOM										
VM1240A0	NYLON SUPPORT CAP	4	PZ										
VM2310A	UPPER DOOR BRACKET HOLES COVER		KVM2310A	UPPER BRACKET HOLE COVER KIT	<table border="1"> <thead> <tr> <th>Code</th> <th>Description</th> <th>Qty</th> <th>UOM</th> </tr> </thead> <tbody> <tr> <td>VM2310A0</td> <td>UPPER DOOR BRACKET HOLES COVER</td> <td>1</td> <td>PZ</td> </tr> </tbody> </table>	Code	Description	Qty	UOM	VM2310A0	UPPER DOOR BRACKET HOLES COVER	1	PZ
Code	Description	Qty	UOM										
VM2310A0	UPPER DOOR BRACKET HOLES COVER	1	PZ										
VM2306A	PIPE STOP PASSIN		KVM2306A	PASSAGE LOCK PIPES CLAMP KIT	<table border="1"> <thead> <tr> <th>Code</th> <th>Description</th> <th>Qty</th> <th>UOM</th> </tr> </thead> <tbody> <tr> <td>VM2306A0</td> <td>PIPE STOP PASSING</td> <td>1</td> <td>PZ</td> </tr> </tbody> </table>	Code	Description	Qty	UOM	VM2306A0	PIPE STOP PASSING	1	PZ
Code	Description	Qty	UOM										
VM2306A0	PIPE STOP PASSING	1	PZ										
VM2307A	PIPE STOP LOCKING COVER		KVM2307A	CLAMPING LOCK PIPES COVER KIT	<table border="1"> <thead> <tr> <th>Code</th> <th>Description</th> <th>Qty</th> <th>UOM</th> </tr> </thead> <tbody> <tr> <td>VM2307A0</td> <td>PIPE STOP LOCKING COVER</td> <td>1</td> <td>PZ</td> </tr> </tbody> </table>	Code	Description	Qty	UOM	VM2307A0	PIPE STOP LOCKING COVER	1	PZ
Code	Description	Qty	UOM										
VM2307A0	PIPE STOP LOCKING COVER	1	PZ										
RC1006A	D8 PET PIPE GUIDE BEND		KRC1006A	20 PCS. Ø8 PET PIPE GUIDE BEND KI	<table border="1"> <thead> <tr> <th>Code</th> <th>Description</th> <th>Qty</th> <th>UOM</th> </tr> </thead> <tbody> <tr> <td>RC1006A0</td> <td>D8 PET PIPE GUIDE BEND</td> <td>20</td> <td>PZ</td> </tr> </tbody> </table>	Code	Description	Qty	UOM	RC1006A0	D8 PET PIPE GUIDE BEND	20	PZ
Code	Description	Qty	UOM										
RC1006A0	D8 PET PIPE GUIDE BEND	20	PZ										







COMPONENT			SPARE PART																										
Code	Description	Image	Code	Description	Components list																								
VM2061A	ACCESSORIES CABLES WALL PASSING		KVM1505A	THROUGH-WALL CONNECTION+DIAPHRAGM KIT	<table border="1"> <thead> <tr> <th>Code</th> <th>Description</th> <th>Qty</th> <th>UOM</th> </tr> </thead> <tbody> <tr> <td>VI1220A1</td> <td>4,2X12 TCB SELF-TAPPING G SCREW</td> <td>1</td> <td>PZ</td> </tr> <tr> <td>VM1505A0</td> <td>WALL PASSING WITH DIAPHRAGM</td> <td>3</td> <td>PZ</td> </tr> <tr> <td>VM2061A0</td> <td>ACCESSORIES CABLES WALL PASSING</td> <td>1</td> <td>PZ</td> </tr> </tbody> </table>	Code	Description	Qty	UOM	VI1220A1	4,2X12 TCB SELF-TAPPING G SCREW	1	PZ	VM1505A0	WALL PASSING WITH DIAPHRAGM	3	PZ	VM2061A0	ACCESSORIES CABLES WALL PASSING	1	PZ								
Code	Description	Qty	UOM																										
VI1220A1	4,2X12 TCB SELF-TAPPING G SCREW	1	PZ																										
VM1505A0	WALL PASSING WITH DIAPHRAGM	3	PZ																										
VM2061A0	ACCESSORIES CABLES WALL PASSING	1	PZ																										
VM1991A	CHEFTOP E SERIES DRIP TRAY		KVM1991A	E SERIES CHEFTOP DRIP TRAY	<table border="1"> <thead> <tr> <th>Code</th> <th>Description</th> <th>Qty</th> <th>UOM</th> </tr> </thead> <tbody> <tr> <td>VM1220A0</td> <td>CLIP TO FIX DRIP TRAY C.T</td> <td>4</td> <td>PZ</td> </tr> <tr> <td>VM1794A0</td> <td>250X4.8 PA66 BLACK CLAMP</td> <td>2</td> <td>PZ</td> </tr> <tr> <td>VM1991A0</td> <td>CHEFTOP E SERIES DRIP TRAY</td> <td>1</td> <td>PZ</td> </tr> <tr> <td>VM2074A0</td> <td>DRIP TRAY FIXING CLIP WITH SCREW</td> <td>4</td> <td>PZ</td> </tr> <tr> <td>VM2103A0</td> <td>CLAMP LOCK</td> <td>2</td> <td>PZ</td> </tr> </tbody> </table>	Code	Description	Qty	UOM	VM1220A0	CLIP TO FIX DRIP TRAY C.T	4	PZ	VM1794A0	250X4.8 PA66 BLACK CLAMP	2	PZ	VM1991A0	CHEFTOP E SERIES DRIP TRAY	1	PZ	VM2074A0	DRIP TRAY FIXING CLIP WITH SCREW	4	PZ	VM2103A0	CLAMP LOCK	2	PZ
Code	Description	Qty	UOM																										
VM1220A0	CLIP TO FIX DRIP TRAY C.T	4	PZ																										
VM1794A0	250X4.8 PA66 BLACK CLAMP	2	PZ																										
VM1991A0	CHEFTOP E SERIES DRIP TRAY	1	PZ																										
VM2074A0	DRIP TRAY FIXING CLIP WITH SCREW	4	PZ																										
VM2103A0	CLAMP LOCK	2	PZ																										
VM2035A	DRAIN PIPE SUPPORT		KVM2035A	DRAIN PIPE SUPPORT 2 PCS. KI	<table border="1"> <thead> <tr> <th>Code</th> <th>Description</th> <th>Qty</th> <th>UOM</th> </tr> </thead> <tbody> <tr> <td>VM2035A0</td> <td>DRAIN PIPE SUPPORT</td> <td>2</td> <td>PZ</td> </tr> </tbody> </table>	Code	Description	Qty	UOM	VM2035A0	DRAIN PIPE SUPPORT	2	PZ																
Code	Description	Qty	UOM																										
VM2035A0	DRAIN PIPE SUPPORT	2	PZ																										
VM1810A	WATER RIGHT SEALING CAP		VM1810A0	WATER RIGHT SEALING CAP																									
VM1811A	WATER LEFT SEALING CAP		VM1811A0	WATER LEFT SEALING CAP																									



COMPONENT			SPARE PART														
Code	Description	Image	Code	Description	Components list												
VM2311A	SCREWS COVER		KVM2311A	SCREWS COVER PLATE KIT	<table border="1"> <thead> <tr> <th>Code</th> <th>Description</th> <th>Qty</th> <th>UOM</th> </tr> </thead> <tbody> <tr> <td>VM2311A0</td> <td>SCREWS COVER</td> <td>1</td> <td>PZ</td> </tr> </tbody> </table>	Code	Description	Qty	UOM	VM2311A0	SCREWS COVER	1	PZ				
Code	Description	Qty	UOM														
VM2311A0	SCREWS COVER	1	PZ														
GN1558A	EXHAUST SEAL		K0H7291A	GASKET AND SEALING DISC CHIMNEY KIT	<table border="1"> <thead> <tr> <th>Code</th> <th>Description</th> <th>Qty</th> <th>UOM</th> </tr> </thead> <tbody> <tr> <td>0H7291A0</td> <td></td> <td>1</td> <td>PZ</td> </tr> <tr> <td>GN1558A0</td> <td>EXHAUST SEA</td> <td>1</td> <td>PZ</td> </tr> </tbody> </table>	Code	Description	Qty	UOM	0H7291A0		1	PZ	GN1558A0	EXHAUST SEA	1	PZ
Code	Description	Qty	UOM														
0H7291A0		1	PZ														
GN1558A0	EXHAUST SEA	1	PZ														
0H7291A			K0H7291A	GASKET AND SEALING DISC CHIMNEY KIT	<table border="1"> <thead> <tr> <th>Code</th> <th>Description</th> <th>Qty</th> <th>UOM</th> </tr> </thead> <tbody> <tr> <td>0H7291A0</td> <td></td> <td>1</td> <td>PZ</td> </tr> <tr> <td>GN1558A0</td> <td>EXHAUST SEA</td> <td>1</td> <td>PZ</td> </tr> </tbody> </table>	Code	Description	Qty	UOM	0H7291A0		1	PZ	GN1558A0	EXHAUST SEA	1	PZ
Code	Description	Qty	UOM														
0H7291A0		1	PZ														
GN1558A0	EXHAUST SEA	1	PZ														
VM1118A	DET&RINSE PLUS TANK LEFT GUIDE		KVM1118A	DET&RINSE TANK LEFT GUIDE KIT FOR MM	<table border="1"> <thead> <tr> <th>Code</th> <th>Description</th> <th>Qty</th> <th>UOM</th> </tr> </thead> <tbody> <tr> <td>V11220A1</td> <td>4,2X12 TCB SELF-TAPPIN G SCREW</td> <td>2</td> <td>PZ</td> </tr> <tr> <td>VM1118A0</td> <td>DET&amp;RINSE PLUS TANK LEFT GUIDE</td> <td>1</td> <td>PZ</td> </tr> </tbody> </table>	Code	Description	Qty	UOM	V11220A1	4,2X12 TCB SELF-TAPPIN G SCREW	2	PZ	VM1118A0	DET&RINSE PLUS TANK LEFT GUIDE	1	PZ
Code	Description	Qty	UOM														
V11220A1	4,2X12 TCB SELF-TAPPIN G SCREW	2	PZ														
VM1118A0	DET&RINSE PLUS TANK LEFT GUIDE	1	PZ														
VM1119A	DET&RINSE PLUS TANK RIGHT GUIDE		KVM1119A	DET&RINSE TANK RIGHT GUIDE KIT FOR MM	<table border="1"> <thead> <tr> <th>Code</th> <th>Description</th> <th>Qty</th> <th>UOM</th> </tr> </thead> <tbody> <tr> <td>V11220A1</td> <td>4,2X12 TCB SELF-TAPPIN G SCREW</td> <td>2</td> <td>PZ</td> </tr> <tr> <td>VM1119A0</td> <td>DET&amp;RINSE PLUS TANK RIGHT GUIDE</td> <td>1</td> <td>PZ</td> </tr> </tbody> </table>	Code	Description	Qty	UOM	V11220A1	4,2X12 TCB SELF-TAPPIN G SCREW	2	PZ	VM1119A0	DET&RINSE PLUS TANK RIGHT GUIDE	1	PZ
Code	Description	Qty	UOM														
V11220A1	4,2X12 TCB SELF-TAPPIN G SCREW	2	PZ														
VM1119A0	DET&RINSE PLUS TANK RIGHT GUIDE	1	PZ														

COMPONENT			SPARE PART																																																																																																					
Code	Description	Image	Code	Description	Components list																																																																																																			
SB1015A			XUC060	DETERGENT TANK KIT FOR PROVER	<table border="1"> <thead> <tr> <th>Code</th> <th>Description</th> <th>Qty</th> <th>UOM</th> </tr> </thead> <tbody> <tr> <td>0H7558B0</td> <td></td> <td>1</td> <td>PZ</td> </tr> <tr> <td>0H7559B0</td> <td></td> <td>2</td> <td>PZ</td> </tr> <tr> <td>0H7656A0</td> <td></td> <td>1</td> <td>PZ</td> </tr> <tr> <td>0H7657A0</td> <td></td> <td>2</td> <td>PZ</td> </tr> <tr> <td>CE1016A0</td> <td></td> <td>2</td> <td>PZ</td> </tr> <tr> <td>CE1630A1</td> <td></td> <td>0.680</td> <td>M</td> </tr> <tr> <td>EL1220A0</td> <td>JG STRAIGHT CONNECTION Ø8-Ø8</td> <td>1</td> <td>PZ</td> </tr> <tr> <td>IP1385A1</td> <td></td> <td>3.520</td> <td>M</td> </tr> <tr> <td>RC1019A0</td> <td>D=10 ELASTIC CLAMP</td> <td>2</td> <td>PZ</td> </tr> <tr> <td>SB1015A1</td> <td></td> <td>1</td> <td>PZ</td> </tr> <tr> <td>TB2820A0</td> <td>PIPE EPDM FOR WASHING SYSTEM</td> <td>2</td> <td>M</td> </tr> <tr> <td>VI1220A1</td> <td>4,2X12 TCB SELF-TAPPIN G SCREW</td> <td>9</td> <td>PZ</td> </tr> <tr> <td>VI1225A0</td> <td>STAINLESS STEEL STRUCTURE RIVET 4X10.1</td> <td>8</td> <td>PZ</td> </tr> <tr> <td>VI1950A0</td> <td>ST. STEEL 4,2X13 TCB SELF-DRILLIN G SCREW</td> <td>4</td> <td>PZ</td> </tr> <tr> <td>VL1047A1</td> <td>D6 PIPE HOLDER - D8 J.G. TERMINAL</td> <td>2</td> <td>PZ</td> </tr> <tr> <td>VM1059A1</td> <td></td> <td>2</td> <td>M</td> </tr> <tr> <td>VM1197A0</td> <td></td> <td>2</td> <td>PZ</td> </tr> <tr> <td>VM1198A0</td> <td></td> <td>8</td> <td>PZ</td> </tr> </tbody> </table>	Code	Description	Qty	UOM	0H7558B0		1	PZ	0H7559B0		2	PZ	0H7656A0		1	PZ	0H7657A0		2	PZ	CE1016A0		2	PZ	CE1630A1		0.680	M	EL1220A0	JG STRAIGHT CONNECTION Ø8-Ø8	1	PZ	IP1385A1		3.520	M	RC1019A0	D=10 ELASTIC CLAMP	2	PZ	SB1015A1		1	PZ	TB2820A0	PIPE EPDM FOR WASHING SYSTEM	2	M	VI1220A1	4,2X12 TCB SELF-TAPPIN G SCREW	9	PZ	VI1225A0	STAINLESS STEEL STRUCTURE RIVET 4X10.1	8	PZ	VI1950A0	ST. STEEL 4,2X13 TCB SELF-DRILLIN G SCREW	4	PZ	VL1047A1	D6 PIPE HOLDER - D8 J.G. TERMINAL	2	PZ	VM1059A1		2	M	VM1197A0		2	PZ	VM1198A0		8	PZ	KSB1015A	4L DETERGENT TANK KIT	<table border="1"> <thead> <tr> <th>Code</th> <th>Description</th> <th>Qty</th> <th>UOM</th> </tr> </thead> <tbody> <tr> <td>IP1385A1</td> <td></td> <td>1.200</td> <td>M</td> </tr> <tr> <td>IP1410A0</td> <td>POLYSTYREN E PACKING TO PROTECT</td> <td>2</td> <td>PZ</td> </tr> <tr> <td>SB1015A1</td> <td></td> <td>1</td> <td>PZ</td> </tr> <tr> <td>VM1059A1</td> <td></td> <td>1.200</td> <td>M</td> </tr> </tbody> </table>	Code	Description	Qty	UOM	IP1385A1		1.200	M	IP1410A0	POLYSTYREN E PACKING TO PROTECT	2	PZ	SB1015A1		1	PZ	VM1059A1		1.200	M
			Code	Description	Qty	UOM																																																																																																		
0H7558B0		1	PZ																																																																																																					
0H7559B0		2	PZ																																																																																																					
0H7656A0		1	PZ																																																																																																					
0H7657A0		2	PZ																																																																																																					
CE1016A0		2	PZ																																																																																																					
CE1630A1		0.680	M																																																																																																					
EL1220A0	JG STRAIGHT CONNECTION Ø8-Ø8	1	PZ																																																																																																					
IP1385A1		3.520	M																																																																																																					
RC1019A0	D=10 ELASTIC CLAMP	2	PZ																																																																																																					
SB1015A1		1	PZ																																																																																																					
TB2820A0	PIPE EPDM FOR WASHING SYSTEM	2	M																																																																																																					
VI1220A1	4,2X12 TCB SELF-TAPPIN G SCREW	9	PZ																																																																																																					
VI1225A0	STAINLESS STEEL STRUCTURE RIVET 4X10.1	8	PZ																																																																																																					
VI1950A0	ST. STEEL 4,2X13 TCB SELF-DRILLIN G SCREW	4	PZ																																																																																																					
VL1047A1	D6 PIPE HOLDER - D8 J.G. TERMINAL	2	PZ																																																																																																					
VM1059A1		2	M																																																																																																					
VM1197A0		2	PZ																																																																																																					
VM1198A0		8	PZ																																																																																																					
Code	Description	Qty	UOM																																																																																																					
IP1385A1		1.200	M																																																																																																					
IP1410A0	POLYSTYREN E PACKING TO PROTECT	2	PZ																																																																																																					
SB1015A1		1	PZ																																																																																																					
VM1059A1		1.200	M																																																																																																					
0H2561A	6 S. DOOR COUNTERBRACKET		0H2561A0	6 S. DOOR COUNTERBRACKET																																																																																																				



COMPONENT			SPARE PART																																		
Code	Description	Image	Code	Description	Components list																																
VM1240A	NYLON SUPPORT CAP		KVM1240A	4 PCS COUNTER BRACKET SUPPORT CAP KIT	<table border="1"> <thead> <tr> <th>Code</th> <th>Description</th> <th>Qty</th> <th>UOM</th> </tr> </thead> <tbody> <tr> <td>VM1240A0</td> <td>NYLON SUPPORT CAP</td> <td>4</td> <td>PZ</td> </tr> </tbody> </table>	Code	Description	Qty	UOM	VM1240A0	NYLON SUPPORT CAP	4	PZ																								
Code	Description	Qty	UOM																																		
VM1240A0	NYLON SUPPORT CAP	4	PZ																																		
VM2282A	MICROSWITCH SUPPORT COVER		KVM2282A	MICROSWITCH SUPPORT PLATE KI	<table border="1"> <thead> <tr> <th>Code</th> <th>Description</th> <th>Qty</th> <th>UOM</th> </tr> </thead> <tbody> <tr> <td>VM2282A0</td> <td>MICROSWITC H SUPPORT COVER</td> <td>1</td> <td>PZ</td> </tr> </tbody> </table>	Code	Description	Qty	UOM	VM2282A0	MICROSWITC H SUPPORT COVER	1	PZ																								
Code	Description	Qty	UOM																																		
VM2282A0	MICROSWITC H SUPPORT COVER	1	PZ																																		
VE1020B	MAGNET DOOR MICROSWITCH		KVE1020B	MICROSWITCH KIT	<table border="1"> <thead> <tr> <th>Code</th> <th>Description</th> <th>Qty</th> <th>UOM</th> </tr> </thead> <tbody> <tr> <td>CE1030A0</td> <td></td> <td>2</td> <td>PZ</td> </tr> <tr> <td>CE1660A0</td> <td>6,3X0,8 FEMALE FASTON COVE</td> <td>2</td> <td>PZ</td> </tr> <tr> <td>CE1730A0</td> <td></td> <td>0.150</td> <td>M</td> </tr> <tr> <td>CE1740A0</td> <td></td> <td>2</td> <td>PZ</td> </tr> <tr> <td>CE1745A0</td> <td></td> <td>1</td> <td>PZ</td> </tr> <tr> <td>VE1020B0</td> <td>MAGNET DOOR MICROSWITC</td> <td>1</td> <td>PZ</td> </tr> <tr> <td>VE1030A1</td> <td>MAGNET FOR DOOR MICROSWITC H D=22,9MM</td> <td>1</td> <td>PZ</td> </tr> </tbody> </table>	Code	Description	Qty	UOM	CE1030A0		2	PZ	CE1660A0	6,3X0,8 FEMALE FASTON COVE	2	PZ	CE1730A0		0.150	M	CE1740A0		2	PZ	CE1745A0		1	PZ	VE1020B0	MAGNET DOOR MICROSWITC	1	PZ	VE1030A1	MAGNET FOR DOOR MICROSWITC H D=22,9MM	1	PZ
Code	Description	Qty	UOM																																		
CE1030A0		2	PZ																																		
CE1660A0	6,3X0,8 FEMALE FASTON COVE	2	PZ																																		
CE1730A0		0.150	M																																		
CE1740A0		2	PZ																																		
CE1745A0		1	PZ																																		
VE1020B0	MAGNET DOOR MICROSWITC	1	PZ																																		
VE1030A1	MAGNET FOR DOOR MICROSWITC H D=22,9MM	1	PZ																																		
0D2295A	GN1-1 XEVC EXTERNAL COVER		0D2295A0	GN1-1 XEVC EXTERNAL COVER																																	







COMPONENT			SPARE PART																																					
Code	Description	Image	Code	Description	Components list																																			
0F1496A	XEVC-0511-E BACK		0F1496A0	XEVC-0511-E BACK																																				
VM1190A	CT BT RIGHT DOOR SPRING LATCH		KVM1190A	CHEFTOP/BAKERTO P DOOR RIGHT LATCH KIT	<table border="1"> <thead> <tr> <th>Code</th> <th>Description</th> <th>Qty</th> <th>UOM</th> </tr> </thead> <tbody> <tr> <td>VI0239A1</td> <td></td> <td>2</td> <td>PZ</td> </tr> <tr> <td>VI1220A1</td> <td>4,2X12 TCB SELF-TAPPIN G SCREW</td> <td>2</td> <td>PZ</td> </tr> <tr> <td>VM1190A2</td> <td>CT BT RIGHT DOOR SPRING LATCH</td> <td>1</td> <td>PZ</td> </tr> <tr> <td>VM1192A1</td> <td>CT BT DOOR SPRING LATCH COVER</td> <td>1</td> <td>PZ</td> </tr> <tr> <td>VM1460A0</td> <td>XBC/XVC RIGHT DOOR LATCH CAP</td> <td>1</td> <td>PZ</td> </tr> </tbody> </table>	Code	Description	Qty	UOM	VI0239A1		2	PZ	VI1220A1	4,2X12 TCB SELF-TAPPIN G SCREW	2	PZ	VM1190A2	CT BT RIGHT DOOR SPRING LATCH	1	PZ	VM1192A1	CT BT DOOR SPRING LATCH COVER	1	PZ	VM1460A0	XBC/XVC RIGHT DOOR LATCH CAP	1	PZ											
Code	Description	Qty	UOM																																					
VI0239A1		2	PZ																																					
VI1220A1	4,2X12 TCB SELF-TAPPIN G SCREW	2	PZ																																					
VM1190A2	CT BT RIGHT DOOR SPRING LATCH	1	PZ																																					
VM1192A1	CT BT DOOR SPRING LATCH COVER	1	PZ																																					
VM1460A0	XBC/XVC RIGHT DOOR LATCH CAP	1	PZ																																					
VM2280A	DOOR LATCH COVE		KVM2280A	VM2280A HANDLE LATCH PLATE COVER KIT	<table border="1"> <thead> <tr> <th>Code</th> <th>Description</th> <th>Qty</th> <th>UOM</th> </tr> </thead> <tbody> <tr> <td>VM2280A0</td> <td>DOOR LATCH COVER</td> <td>1</td> <td>PZ</td> </tr> </tbody> </table>	Code	Description	Qty	UOM	VM2280A0	DOOR LATCH COVER	1	PZ																											
Code	Description	Qty	UOM																																					
VM2280A0	DOOR LATCH COVER	1	PZ																																					
VM1192A	CT BT DOOR SPRING LATCH COVER		<p>KVM1191A</p> <p>CHEFTOP/BAKERTO P DOOR LEFT LATCH KIT</p> <p>KVM1190A</p> <p>CHEFTOP/BAKERTO P DOOR RIGHT LATCH KIT</p>	<table border="1"> <thead> <tr> <th>Code</th> <th>Description</th> <th>Qty</th> <th>UOM</th> </tr> </thead> <tbody> <tr> <td>VI0239A1</td> <td></td> <td>2</td> <td>PZ</td> </tr> <tr> <td>VI1220A1</td> <td>4,2X12 TCB SELF-TAPPIN G SCREW</td> <td>2</td> <td>PZ</td> </tr> <tr> <td>VM1191A2</td> <td>CT BT LEFT DOOR SPRING LATCH</td> <td>1</td> <td>PZ</td> </tr> <tr> <td>VM1192A1</td> <td>CT BT DOOR SPRING LATCH COVER</td> <td>1</td> <td>PZ</td> </tr> <tr> <td>VM1460A0</td> <td>XBC/XVC RIGHT DOOR LATCH CAP</td> <td>1</td> <td>PZ</td> </tr> </tbody> </table> <table border="1"> <thead> <tr> <th>Code</th> <th>Description</th> <th>Qty</th> <th>UOM</th> </tr> </thead> <tbody> <tr> <td>VI0239A1</td> <td></td> <td>2</td> <td>PZ</td> </tr> <tr> <td>VI1220A1</td> <td>4,2X12 TCB SELF-TAPPIN G SCREW</td> <td>2</td> <td>PZ</td> </tr> </tbody> </table>	Code	Description	Qty	UOM	VI0239A1		2	PZ	VI1220A1	4,2X12 TCB SELF-TAPPIN G SCREW	2	PZ	VM1191A2	CT BT LEFT DOOR SPRING LATCH	1	PZ	VM1192A1	CT BT DOOR SPRING LATCH COVER	1	PZ	VM1460A0	XBC/XVC RIGHT DOOR LATCH CAP	1	PZ	Code	Description	Qty	UOM	VI0239A1		2	PZ	VI1220A1	4,2X12 TCB SELF-TAPPIN G SCREW	2	PZ
Code	Description	Qty	UOM																																					
VI0239A1		2	PZ																																					
VI1220A1	4,2X12 TCB SELF-TAPPIN G SCREW	2	PZ																																					
VM1191A2	CT BT LEFT DOOR SPRING LATCH	1	PZ																																					
VM1192A1	CT BT DOOR SPRING LATCH COVER	1	PZ																																					
VM1460A0	XBC/XVC RIGHT DOOR LATCH CAP	1	PZ																																					
Code	Description	Qty	UOM																																					
VI0239A1		2	PZ																																					
VI1220A1	4,2X12 TCB SELF-TAPPIN G SCREW	2	PZ																																					







COMPONENT			SPARE PART																										
Code	Description	Image	Code	Description	Components list																								
VM1192A	CT BT DOOR SPRING LATCH COVER		KVM1190A	CHEFTOP/BAKERTO P DOOR RIGHT LATCH KIT	<table border="1"> <thead> <tr> <th>Code</th> <th>Description</th> <th>Qty</th> <th>UOM</th> </tr> </thead> <tbody> <tr> <td>VM1190A2</td> <td>CT BT RIGHT DOOR SPRING LATCH</td> <td>1</td> <td>PZ</td> </tr> <tr> <td>VM1192A1</td> <td>CT BT DOOR SPRING LATCH COVER</td> <td>1</td> <td>PZ</td> </tr> <tr> <td>VM1460A0</td> <td>XBC/XVC RIGHT DOOR LATCH CAP</td> <td>1</td> <td>PZ</td> </tr> </tbody> </table>	Code	Description	Qty	UOM	VM1190A2	CT BT RIGHT DOOR SPRING LATCH	1	PZ	VM1192A1	CT BT DOOR SPRING LATCH COVER	1	PZ	VM1460A0	XBC/XVC RIGHT DOOR LATCH CAP	1	PZ								
					Code	Description	Qty	UOM																					
					VM1190A2	CT BT RIGHT DOOR SPRING LATCH	1	PZ																					
VM1192A1	CT BT DOOR SPRING LATCH COVER	1	PZ																										
VM1460A0	XBC/XVC RIGHT DOOR LATCH CAP	1	PZ																										
<table border="1"> <thead> <tr> <th>Code</th> <th>Description</th> <th>Qty</th> <th>UOM</th> </tr> </thead> <tbody> <tr> <td>VM2281A0</td> <td>DOOR LATCH HOLES COVER</td> <td>1</td> <td>PZ</td> </tr> </tbody> </table>	Code	Description	Qty	UOM	VM2281A0	DOOR LATCH HOLES COVER	1	PZ																					
Code	Description	Qty	UOM																										
VM2281A0	DOOR LATCH HOLES COVER	1	PZ																										
<table border="1"> <thead> <tr> <th>Code</th> <th>Description</th> <th>Qty</th> <th>UOM</th> </tr> </thead> <tbody> <tr> <td>VM1192A1</td> <td>CT BT DOOR SPRING LATCH COVER</td> <td>1</td> <td>PZ</td> </tr> <tr> <td>VM1460A0</td> <td>XBC/XVC RIGHT DOOR LATCH CAP</td> <td>1</td> <td>PZ</td> </tr> </tbody> </table>	Code	Description	Qty	UOM	VM1192A1	CT BT DOOR SPRING LATCH COVER	1	PZ	VM1460A0	XBC/XVC RIGHT DOOR LATCH CAP	1	PZ																	
Code	Description	Qty	UOM																										
VM1192A1	CT BT DOOR SPRING LATCH COVER	1	PZ																										
VM1460A0	XBC/XVC RIGHT DOOR LATCH CAP	1	PZ																										
VM2281A	DOOR LATCH HOLES COVER		KVM2281A	HOLE PLATE COVER KIT	<table border="1"> <thead> <tr> <th>Code</th> <th>Description</th> <th>Qty</th> <th>UOM</th> </tr> </thead> <tbody> <tr> <td>VM2281A0</td> <td>DOOR LATCH HOLES COVER</td> <td>1</td> <td>PZ</td> </tr> </tbody> </table>	Code	Description	Qty	UOM	VM2281A0	DOOR LATCH HOLES COVER	1	PZ																
Code	Description	Qty	UOM																										
VM2281A0	DOOR LATCH HOLES COVER	1	PZ																										
VM1192A	CT BT DOOR SPRING LATCH COVER		KVM1191A	CHEFTOP/BAKERTO P DOOR LEFT LATCH KIT	<table border="1"> <thead> <tr> <th>Code</th> <th>Description</th> <th>Qty</th> <th>UOM</th> </tr> </thead> <tbody> <tr> <td>VI0239A1</td> <td></td> <td>2</td> <td>PZ</td> </tr> <tr> <td>VI1220A1</td> <td>4,2X12 TCB SELF-TAPPIN G SCREW</td> <td>2</td> <td>PZ</td> </tr> <tr> <td>VM1191A2</td> <td>CT BT LEFT DOOR SPRING LATCH</td> <td>1</td> <td>PZ</td> </tr> <tr> <td>VM1192A1</td> <td>CT BT DOOR SPRING LATCH COVER</td> <td>1</td> <td>PZ</td> </tr> <tr> <td>VM1460A0</td> <td>XBC/XVC RIGHT DOOR LATCH CAP</td> <td>1</td> <td>PZ</td> </tr> </tbody> </table>	Code	Description	Qty	UOM	VI0239A1		2	PZ	VI1220A1	4,2X12 TCB SELF-TAPPIN G SCREW	2	PZ	VM1191A2	CT BT LEFT DOOR SPRING LATCH	1	PZ	VM1192A1	CT BT DOOR SPRING LATCH COVER	1	PZ	VM1460A0	XBC/XVC RIGHT DOOR LATCH CAP	1	PZ
					Code	Description	Qty	UOM																					
					VI0239A1		2	PZ																					
					VI1220A1	4,2X12 TCB SELF-TAPPIN G SCREW	2	PZ																					
					VM1191A2	CT BT LEFT DOOR SPRING LATCH	1	PZ																					
					VM1192A1	CT BT DOOR SPRING LATCH COVER	1	PZ																					
			VM1460A0	XBC/XVC RIGHT DOOR LATCH CAP	1	PZ																							
			<table border="1"> <thead> <tr> <th>Code</th> <th>Description</th> <th>Qty</th> <th>UOM</th> </tr> </thead> <tbody> <tr> <td>VI0239A1</td> <td></td> <td>2</td> <td>PZ</td> </tr> <tr> <td>VI1220A1</td> <td>4,2X12 TCB SELF-TAPPIN G SCREW</td> <td>2</td> <td>PZ</td> </tr> <tr> <td>VM1190A2</td> <td>CT BT RIGHT DOOR SPRING LATCH</td> <td>1</td> <td>PZ</td> </tr> <tr> <td>VM1192A1</td> <td>CT BT DOOR SPRING LATCH COVER</td> <td>1</td> <td>PZ</td> </tr> <tr> <td>VM1460A0</td> <td>XBC/XVC RIGHT DOOR LATCH CAP</td> <td>1</td> <td>PZ</td> </tr> </tbody> </table>	Code	Description	Qty	UOM	VI0239A1		2	PZ	VI1220A1	4,2X12 TCB SELF-TAPPIN G SCREW	2	PZ	VM1190A2	CT BT RIGHT DOOR SPRING LATCH	1	PZ	VM1192A1	CT BT DOOR SPRING LATCH COVER	1	PZ	VM1460A0	XBC/XVC RIGHT DOOR LATCH CAP	1	PZ		
			Code	Description	Qty	UOM																							
			VI0239A1		2	PZ																							
			VI1220A1	4,2X12 TCB SELF-TAPPIN G SCREW	2	PZ																							
			VM1190A2	CT BT RIGHT DOOR SPRING LATCH	1	PZ																							
VM1192A1	CT BT DOOR SPRING LATCH COVER	1	PZ																										
VM1460A0	XBC/XVC RIGHT DOOR LATCH CAP	1	PZ																										
<table border="1"> <thead> <tr> <th>Code</th> <th>Description</th> <th>Qty</th> <th>UOM</th> </tr> </thead> <tbody> <tr> <td>VI0239A1</td> <td></td> <td>2</td> <td>PZ</td> </tr> <tr> <td>VI1220A1</td> <td>4,2X12 TCB SELF-TAPPIN G SCREW</td> <td>2</td> <td>PZ</td> </tr> <tr> <td>VM1190A2</td> <td>CT BT RIGHT DOOR SPRING LATCH</td> <td>1</td> <td>PZ</td> </tr> <tr> <td>VM1192A1</td> <td>CT BT DOOR SPRING LATCH COVER</td> <td>1</td> <td>PZ</td> </tr> <tr> <td>VM1460A0</td> <td>XBC/XVC RIGHT DOOR LATCH CAP</td> <td>1</td> <td>PZ</td> </tr> </tbody> </table>	Code	Description	Qty	UOM	VI0239A1		2	PZ	VI1220A1	4,2X12 TCB SELF-TAPPIN G SCREW	2	PZ	VM1190A2	CT BT RIGHT DOOR SPRING LATCH	1	PZ	VM1192A1	CT BT DOOR SPRING LATCH COVER	1	PZ	VM1460A0	XBC/XVC RIGHT DOOR LATCH CAP	1	PZ					
Code	Description	Qty	UOM																										
VI0239A1		2	PZ																										
VI1220A1	4,2X12 TCB SELF-TAPPIN G SCREW	2	PZ																										
VM1190A2	CT BT RIGHT DOOR SPRING LATCH	1	PZ																										
VM1192A1	CT BT DOOR SPRING LATCH COVER	1	PZ																										
VM1460A0	XBC/XVC RIGHT DOOR LATCH CAP	1	PZ																										
<table border="1"> <thead> <tr> <th>Code</th> <th>Description</th> <th>Qty</th> <th>UOM</th> </tr> </thead> <tbody> <tr> <td>VI0239A1</td> <td></td> <td>2</td> <td>PZ</td> </tr> <tr> <td>VI1220A1</td> <td>4,2X12 TCB SELF-TAPPIN G SCREW</td> <td>2</td> <td>PZ</td> </tr> <tr> <td>VM1190A2</td> <td>CT BT RIGHT DOOR SPRING LATCH</td> <td>1</td> <td>PZ</td> </tr> <tr> <td>VM1192A1</td> <td>CT BT DOOR SPRING LATCH COVER</td> <td>1</td> <td>PZ</td> </tr> <tr> <td>VM1460A0</td> <td>XBC/XVC RIGHT DOOR LATCH CAP</td> <td>1</td> <td>PZ</td> </tr> </tbody> </table>	Code	Description	Qty	UOM	VI0239A1		2	PZ	VI1220A1	4,2X12 TCB SELF-TAPPIN G SCREW	2	PZ	VM1190A2	CT BT RIGHT DOOR SPRING LATCH	1	PZ	VM1192A1	CT BT DOOR SPRING LATCH COVER	1	PZ	VM1460A0	XBC/XVC RIGHT DOOR LATCH CAP	1	PZ					
Code	Description	Qty	UOM																										
VI0239A1		2	PZ																										
VI1220A1	4,2X12 TCB SELF-TAPPIN G SCREW	2	PZ																										
VM1190A2	CT BT RIGHT DOOR SPRING LATCH	1	PZ																										
VM1192A1	CT BT DOOR SPRING LATCH COVER	1	PZ																										
VM1460A0	XBC/XVC RIGHT DOOR LATCH CAP	1	PZ																										
<table border="1"> <thead> <tr> <th>Code</th> <th>Description</th> <th>Qty</th> <th>UOM</th> </tr> </thead> <tbody> <tr> <td>VI0239A1</td> <td></td> <td>2</td> <td>PZ</td> </tr> <tr> <td>VI1220A1</td> <td>4,2X12 TCB SELF-TAPPIN G SCREW</td> <td>2</td> <td>PZ</td> </tr> <tr> <td>VM1190A2</td> <td>CT BT RIGHT DOOR SPRING LATCH</td> <td>1</td> <td>PZ</td> </tr> <tr> <td>VM1192A1</td> <td>CT BT DOOR SPRING LATCH COVER</td> <td>1</td> <td>PZ</td> </tr> <tr> <td>VM1460A0</td> <td>XBC/XVC RIGHT DOOR LATCH CAP</td> <td>1</td> <td>PZ</td> </tr> </tbody> </table>	Code	Description	Qty	UOM	VI0239A1		2	PZ	VI1220A1	4,2X12 TCB SELF-TAPPIN G SCREW	2	PZ	VM1190A2	CT BT RIGHT DOOR SPRING LATCH	1	PZ	VM1192A1	CT BT DOOR SPRING LATCH COVER	1	PZ	VM1460A0	XBC/XVC RIGHT DOOR LATCH CAP	1	PZ					
Code	Description	Qty	UOM																										
VI0239A1		2	PZ																										
VI1220A1	4,2X12 TCB SELF-TAPPIN G SCREW	2	PZ																										
VM1190A2	CT BT RIGHT DOOR SPRING LATCH	1	PZ																										
VM1192A1	CT BT DOOR SPRING LATCH COVER	1	PZ																										
VM1460A0	XBC/XVC RIGHT DOOR LATCH CAP	1	PZ																										
<table border="1"> <thead> <tr> <th>Code</th> <th>Description</th> <th>Qty</th> <th>UOM</th> </tr> </thead> <tbody> <tr> <td>VI0239A1</td> <td></td> <td>2</td> <td>PZ</td> </tr> <tr> <td>VI1220A1</td> <td>4,2X12 TCB SELF-TAPPIN G SCREW</td> <td>2</td> <td>PZ</td> </tr> <tr> <td>VM1190A2</td> <td>CT BT RIGHT DOOR SPRING LATCH</td> <td>1</td> <td>PZ</td> </tr> <tr> <td>VM1192A1</td> <td>CT BT DOOR SPRING LATCH COVER</td> <td>1</td> <td>PZ</td> </tr> <tr> <td>VM1460A0</td> <td>XBC/XVC RIGHT DOOR LATCH CAP</td> <td>1</td> <td>PZ</td> </tr> </tbody> </table>	Code	Description	Qty	UOM	VI0239A1		2	PZ	VI1220A1	4,2X12 TCB SELF-TAPPIN G SCREW	2	PZ	VM1190A2	CT BT RIGHT DOOR SPRING LATCH	1	PZ	VM1192A1	CT BT DOOR SPRING LATCH COVER	1	PZ	VM1460A0	XBC/XVC RIGHT DOOR LATCH CAP	1	PZ					
Code	Description	Qty	UOM																										
VI0239A1		2	PZ																										
VI1220A1	4,2X12 TCB SELF-TAPPIN G SCREW	2	PZ																										
VM1190A2	CT BT RIGHT DOOR SPRING LATCH	1	PZ																										
VM1192A1	CT BT DOOR SPRING LATCH COVER	1	PZ																										
VM1460A0	XBC/XVC RIGHT DOOR LATCH CAP	1	PZ																										
<table border="1"> <thead> <tr> <th>Code</th> <th>Description</th> <th>Qty</th> <th>UOM</th> </tr> </thead> <tbody> <tr> <td>VI0239A1</td> <td></td> <td>2</td> <td>PZ</td> </tr> <tr> <td>VI1220A1</td> <td>4,2X12 TCB SELF-TAPPIN G SCREW</td> <td>2</td> <td>PZ</td> </tr> <tr> <td>VM1190A2</td> <td>CT BT RIGHT DOOR SPRING LATCH</td> <td>1</td> <td>PZ</td> </tr> <tr> <td>VM1192A1</td> <td>CT BT DOOR SPRING LATCH COVER</td> <td>1</td> <td>PZ</td> </tr> <tr> <td>VM1460A0</td> <td>XBC/XVC RIGHT DOOR LATCH CAP</td> <td>1</td> <td>PZ</td> </tr> </tbody> </table>	Code	Description	Qty	UOM	VI0239A1		2	PZ	VI1220A1	4,2X12 TCB SELF-TAPPIN G SCREW	2	PZ	VM1190A2	CT BT RIGHT DOOR SPRING LATCH	1	PZ	VM1192A1	CT BT DOOR SPRING LATCH COVER	1	PZ	VM1460A0	XBC/XVC RIGHT DOOR LATCH CAP	1	PZ					
Code	Description	Qty	UOM																										
VI0239A1		2	PZ																										
VI1220A1	4,2X12 TCB SELF-TAPPIN G SCREW	2	PZ																										
VM1190A2	CT BT RIGHT DOOR SPRING LATCH	1	PZ																										
VM1192A1	CT BT DOOR SPRING LATCH COVER	1	PZ																										
VM1460A0	XBC/XVC RIGHT DOOR LATCH CAP	1	PZ																										







COMPONENT			SPARE PART																										
Code	Description	Image	Code	Description	Components list																								
VM1191A	CT BT LEFT DOOR SPRING LATCH		KVM1191A	CHEFTOP/BAKERTO P DOOR LEFT LATCH KIT	<table border="1"> <thead> <tr> <th>Code</th> <th>Description</th> <th>Qty</th> <th>UOM</th> </tr> </thead> <tbody> <tr> <td>VI0239A1</td> <td></td> <td>2</td> <td>PZ</td> </tr> <tr> <td>VI1220A1</td> <td>4,2X12 TCB SELF-TAPPING SCREW</td> <td>2</td> <td>PZ</td> </tr> <tr> <td>VM1191A2</td> <td>CT BT LEFT DOOR SPRING LATCH</td> <td>1</td> <td>PZ</td> </tr> <tr> <td>VM1192A1</td> <td>CT BT DOOR SPRING LATCH COVER</td> <td>1</td> <td>PZ</td> </tr> <tr> <td>VM1460A0</td> <td>XBC/XVC RIGHT DOOR LATCH CAP</td> <td>1</td> <td>PZ</td> </tr> </tbody> </table>	Code	Description	Qty	UOM	VI0239A1		2	PZ	VI1220A1	4,2X12 TCB SELF-TAPPING SCREW	2	PZ	VM1191A2	CT BT LEFT DOOR SPRING LATCH	1	PZ	VM1192A1	CT BT DOOR SPRING LATCH COVER	1	PZ	VM1460A0	XBC/XVC RIGHT DOOR LATCH CAP	1	PZ
Code	Description	Qty	UOM																										
VI0239A1		2	PZ																										
VI1220A1	4,2X12 TCB SELF-TAPPING SCREW	2	PZ																										
VM1191A2	CT BT LEFT DOOR SPRING LATCH	1	PZ																										
VM1192A1	CT BT DOOR SPRING LATCH COVER	1	PZ																										
VM1460A0	XBC/XVC RIGHT DOOR LATCH CAP	1	PZ																										
0H2561A	6 S. DOOR COUNTERBRACKET		0H2561A0	6 S. DOOR COUNTERBRACKET																									
VM2352A	LOWER DOOR BRACKET SCREW LEFT COVER		VM2352A0	LOWER DOOR BRACKET SCREW LEFT COVER																									
VM2353A	LOWER DOOR BRACKET SCREW RIGHT COVER		VM2353A0	LOWER DOOR BRACKET SCREW RIGHT COVER																									
VM1240A	NYLON SUPPORT CAP		KVM1240A	4 PCS COUNTER BRACKET SUPPORT CAP KIT	<table border="1"> <thead> <tr> <th>Code</th> <th>Description</th> <th>Qty</th> <th>UOM</th> </tr> </thead> <tbody> <tr> <td>VM1240A0</td> <td>NYLON SUPPORT CAP</td> <td>4</td> <td>PZ</td> </tr> </tbody> </table>	Code	Description	Qty	UOM	VM1240A0	NYLON SUPPORT CAP	4	PZ																
Code	Description	Qty	UOM																										
VM1240A0	NYLON SUPPORT CAP	4	PZ																										







COMPONENT			SPARE PART																										
Code	Description	Image	Code	Description	Components list																								
VM2273A	6 S. LEFT LOWER DOOR BRACKET		KVM2273A	MIND.MAPS LOWER LEFT DOOR BRACKET KIT	<table border="1"> <thead> <tr> <th>Code</th> <th>Description</th> <th>Qty</th> <th>UOM</th> </tr> </thead> <tbody> <tr> <td>0H7330A0</td> <td>DOOR LOWER BRACKET WASHER</td> <td>2</td> <td>PZ</td> </tr> <tr> <td>VI1995A0</td> <td>M5X25 ST.STEEL SCREW</td> <td>4</td> <td>PZ</td> </tr> <tr> <td>VM2273A0</td> <td>6 S. LEFT LOWER DOOR BRACKET</td> <td>1</td> <td>PZ</td> </tr> <tr> <td>VM2352A0</td> <td>LOWER DOOR BRACKET SCREW LEFT COVER</td> <td>2</td> <td>PZ</td> </tr> <tr> <td>VM2353A0</td> <td>LOWER DOOR BRACKET SCREW RIGHT COVER</td> <td>1</td> <td>PZ</td> </tr> </tbody> </table>	Code	Description	Qty	UOM	0H7330A0	DOOR LOWER BRACKET WASHER	2	PZ	VI1995A0	M5X25 ST.STEEL SCREW	4	PZ	VM2273A0	6 S. LEFT LOWER DOOR BRACKET	1	PZ	VM2352A0	LOWER DOOR BRACKET SCREW LEFT COVER	2	PZ	VM2353A0	LOWER DOOR BRACKET SCREW RIGHT COVER	1	PZ
Code	Description	Qty	UOM																										
0H7330A0	DOOR LOWER BRACKET WASHER	2	PZ																										
VI1995A0	M5X25 ST.STEEL SCREW	4	PZ																										
VM2273A0	6 S. LEFT LOWER DOOR BRACKET	1	PZ																										
VM2352A0	LOWER DOOR BRACKET SCREW LEFT COVER	2	PZ																										
VM2353A0	LOWER DOOR BRACKET SCREW RIGHT COVER	1	PZ																										
0H2561A	6 S. DOOR COUNTERBRACKET		0H2561A0	6 S. DOOR COUNTERBRACKET																									
VM1240A	NYLON SUPPORT CAP		KVM1240A	4 PCS COUNTER BRACKET SUPPORT CAP KIT	<table border="1"> <thead> <tr> <th>Code</th> <th>Description</th> <th>Qty</th> <th>UOM</th> </tr> </thead> <tbody> <tr> <td>VM1240A0</td> <td>NYLON SUPPORT CAP</td> <td>4</td> <td>PZ</td> </tr> </tbody> </table>	Code	Description	Qty	UOM	VM1240A0	NYLON SUPPORT CAP	4	PZ																
Code	Description	Qty	UOM																										
VM1240A0	NYLON SUPPORT CAP	4	PZ																										
VM2298A	DOOR BRACKET UPPER COVER		KVM2298A	MIND.MAPS DOOR UPPER BRACKET COVER KIT	<table border="1"> <thead> <tr> <th>Code</th> <th>Description</th> <th>Qty</th> <th>UOM</th> </tr> </thead> <tbody> <tr> <td>VI1220A0</td> <td>SELF-TAPPING SCREW 4,2X12 TCB</td> <td>2</td> <td>PZ</td> </tr> <tr> <td>VM2298A0</td> <td>DOOR BRACKET UPPER COVER</td> <td>1</td> <td>PZ</td> </tr> </tbody> </table>	Code	Description	Qty	UOM	VI1220A0	SELF-TAPPING SCREW 4,2X12 TCB	2	PZ	VM2298A0	DOOR BRACKET UPPER COVER	1	PZ												
Code	Description	Qty	UOM																										
VI1220A0	SELF-TAPPING SCREW 4,2X12 TCB	2	PZ																										
VM2298A0	DOOR BRACKET UPPER COVER	1	PZ																										

COMPONENT			SPARE PART																														
Code	Description	Image	Code	Description	Components list																												
VM2271A	LEFT DOOR UPPER BRACKET		KVM2271A	MIND.MAPS UPPER LEFT DOOR BRACKET KIT	<table border="1"> <thead> <tr> <th>Code</th> <th>Description</th> <th>Qty</th> <th>UOM</th> </tr> </thead> <tbody> <tr> <td>VI1220A1</td> <td>4,2X12 TCB SELF-TAPPING SCREW</td> <td>2</td> <td>PZ</td> </tr> <tr> <td>VI1995A0</td> <td>M5X25 ST.STEEL SCREW</td> <td>4</td> <td>PZ</td> </tr> <tr> <td>VI1997A0</td> <td>5X10X1 FLAT WASHER</td> <td>4</td> <td>PZ</td> </tr> <tr> <td>VM2271A0</td> <td>LEFT DOOR UPPER BRACKET</td> <td>1</td> <td>PZ</td> </tr> <tr> <td>VM2298A0</td> <td>DOOR BRACKET UPPER COVER</td> <td>1</td> <td>PZ</td> </tr> </tbody> </table>	Code	Description	Qty	UOM	VI1220A1	4,2X12 TCB SELF-TAPPING SCREW	2	PZ	VI1995A0	M5X25 ST.STEEL SCREW	4	PZ	VI1997A0	5X10X1 FLAT WASHER	4	PZ	VM2271A0	LEFT DOOR UPPER BRACKET	1	PZ	VM2298A0	DOOR BRACKET UPPER COVER	1	PZ				
Code	Description	Qty	UOM																														
VI1220A1	4,2X12 TCB SELF-TAPPING SCREW	2	PZ																														
VI1995A0	M5X25 ST.STEEL SCREW	4	PZ																														
VI1997A0	5X10X1 FLAT WASHER	4	PZ																														
VM2271A0	LEFT DOOR UPPER BRACKET	1	PZ																														
VM2298A0	DOOR BRACKET UPPER COVER	1	PZ																														
0D2298A	XEVC-0511 LEFT SIDE PANEL																																
0D2299A	XEVC-0511 EXTERNAL RIGHT SIDE																																
RC1243A	Ø10F-Ø10M ELBOW CONNECTION + JG END KIT		KVL1117A	EU FILTER PRESSURE REDUCER KIT	<table border="1"> <thead> <tr> <th>Code</th> <th>Description</th> <th>Qty</th> <th>UOM</th> </tr> </thead> <tbody> <tr> <td>0H7472A1</td> <td></td> <td>1</td> <td>PZ</td> </tr> <tr> <td>RC1004A0</td> <td>D10-D8-8 Y CONNECTION</td> <td>1</td> <td>PZ</td> </tr> <tr> <td>RC1243A0</td> <td>Ø10F-Ø10M ELBOW CONNECTION + JG END KIT</td> <td>1</td> <td>PZ</td> </tr> <tr> <td>RC1372A0</td> <td>Ø10M-1/4 M CIL. STRAIGHT FITTING</td> <td>2</td> <td>PZ</td> </tr> <tr> <td>VI1013A1</td> <td>30.5X39.5X3 NYLON FLAT WASHER</td> <td>1</td> <td>PZ</td> </tr> <tr> <td>VI1220A1</td> <td>4,2X12 TCB SELF-TAPPING G SCREW</td> <td>2</td> <td>PZ</td> </tr> </tbody> </table>	Code	Description	Qty	UOM	0H7472A1		1	PZ	RC1004A0	D10-D8-8 Y CONNECTION	1	PZ	RC1243A0	Ø10F-Ø10M ELBOW CONNECTION + JG END KIT	1	PZ	RC1372A0	Ø10M-1/4 M CIL. STRAIGHT FITTING	2	PZ	VI1013A1	30.5X39.5X3 NYLON FLAT WASHER	1	PZ	VI1220A1	4,2X12 TCB SELF-TAPPING G SCREW	2	PZ
Code	Description	Qty	UOM																														
0H7472A1		1	PZ																														
RC1004A0	D10-D8-8 Y CONNECTION	1	PZ																														
RC1243A0	Ø10F-Ø10M ELBOW CONNECTION + JG END KIT	1	PZ																														
RC1372A0	Ø10M-1/4 M CIL. STRAIGHT FITTING	2	PZ																														
VI1013A1	30.5X39.5X3 NYLON FLAT WASHER	1	PZ																														
VI1220A1	4,2X12 TCB SELF-TAPPING G SCREW	2	PZ																														





COMPONENT			SPARE PART																																		
Code	Description	Image	Code	Description	Components list																																
RC1243A	Ø10F-Ø10M ELBOW CONNECTION + JG END KIT		KVL1117A	EU FILTER PRESSURE REDUCER KIT	<table border="1"> <thead> <tr> <th>Code</th> <th>Description</th> <th>Qty</th> <th>UOM</th> </tr> </thead> <tbody> <tr> <td>VL1014A0</td> <td>PRESSURE REDUCER WITH DISTRIBUTOR</td> <td>1</td> <td>PZ</td> </tr> <tr> <td>VL1014B0</td> <td>PRESSURE REDUCER WITH DISTRIBUTOR</td> <td>1</td> <td>PZ</td> </tr> <tr> <td>VL1034C0</td> <td></td> <td>1</td> <td>PZ</td> </tr> <tr> <td>VL1062C0</td> <td></td> <td>1</td> <td>PZ</td> </tr> <tr> <td>VM1053A0</td> <td>1/8" CAP + O-RING</td> <td>2</td> <td>PZ</td> </tr> <tr> <td>VM1054A0</td> <td>H7.8 PRESSURE REDUCER RING NUT</td> <td>1</td> <td>PZ</td> </tr> </tbody> </table>	Code	Description	Qty	UOM	VL1014A0	PRESSURE REDUCER WITH DISTRIBUTOR	1	PZ	VL1014B0	PRESSURE REDUCER WITH DISTRIBUTOR	1	PZ	VL1034C0		1	PZ	VL1062C0		1	PZ	VM1053A0	1/8" CAP + O-RING	2	PZ	VM1054A0	H7.8 PRESSURE REDUCER RING NUT	1	PZ				
			Code	Description	Qty	UOM																															
VL1014A0	PRESSURE REDUCER WITH DISTRIBUTOR	1	PZ																																		
VL1014B0	PRESSURE REDUCER WITH DISTRIBUTOR	1	PZ																																		
VL1034C0		1	PZ																																		
VL1062C0		1	PZ																																		
VM1053A0	1/8" CAP + O-RING	2	PZ																																		
VM1054A0	H7.8 PRESSURE REDUCER RING NUT	1	PZ																																		
KRC1243A	Ø10F-Ø10M ELBOW CONNECTION + JG END KIT				<table border="1"> <thead> <tr> <th>Code</th> <th>Description</th> <th>Qty</th> <th>UOM</th> </tr> </thead> <tbody> <tr> <td>RC1243A0</td> <td>Ø10F-Ø10M ELBOW CONNECTION + JG END KIT</td> <td>10</td> <td>PZ</td> </tr> </tbody> </table>	Code	Description	Qty	UOM	RC1243A0	Ø10F-Ø10M ELBOW CONNECTION + JG END KIT	10	PZ																								
Code	Description	Qty	UOM																																		
RC1243A0	Ø10F-Ø10M ELBOW CONNECTION + JG END KIT	10	PZ																																		
VL1014A	PRESSURE REDUCER WITH DISTRIBUTOR																																				
RC1372A	Ø10M-1/4 M CIL. STRAIGHT FITTING		KVL1117A	EU FILTER PRESSURE REDUCER KIT	<table border="1"> <thead> <tr> <th>Code</th> <th>Description</th> <th>Qty</th> <th>UOM</th> </tr> </thead> <tbody> <tr> <td>0H7472A1</td> <td></td> <td>1</td> <td>PZ</td> </tr> <tr> <td>RC1004A0</td> <td>D10-D8-8 Y CONNECTION</td> <td>1</td> <td>PZ</td> </tr> <tr> <td>RC1243A0</td> <td>Ø10F-Ø10M ELBOW CONNECTION + JG END KIT</td> <td>1</td> <td>PZ</td> </tr> <tr> <td>RC1372A0</td> <td>Ø10M-1/4 M CIL. STRAIGHT FITTING</td> <td>2</td> <td>PZ</td> </tr> <tr> <td>VI1013A1</td> <td>30.5X39.5X3 NYLON FLAT WASHER</td> <td>1</td> <td>PZ</td> </tr> <tr> <td>VI1220A1</td> <td>4,2X12 TCB SELF-TAPPING SCREW</td> <td>2</td> <td>PZ</td> </tr> <tr> <td>VL1014A0</td> <td>PRESSURE REDUCER WITH DISTRIBUTOR</td> <td>1</td> <td>PZ</td> </tr> </tbody> </table>	Code	Description	Qty	UOM	0H7472A1		1	PZ	RC1004A0	D10-D8-8 Y CONNECTION	1	PZ	RC1243A0	Ø10F-Ø10M ELBOW CONNECTION + JG END KIT	1	PZ	RC1372A0	Ø10M-1/4 M CIL. STRAIGHT FITTING	2	PZ	VI1013A1	30.5X39.5X3 NYLON FLAT WASHER	1	PZ	VI1220A1	4,2X12 TCB SELF-TAPPING SCREW	2	PZ	VL1014A0	PRESSURE REDUCER WITH DISTRIBUTOR	1	PZ
			Code	Description	Qty	UOM																															
			0H7472A1		1	PZ																															
			RC1004A0	D10-D8-8 Y CONNECTION	1	PZ																															
			RC1243A0	Ø10F-Ø10M ELBOW CONNECTION + JG END KIT	1	PZ																															
			RC1372A0	Ø10M-1/4 M CIL. STRAIGHT FITTING	2	PZ																															
			VI1013A1	30.5X39.5X3 NYLON FLAT WASHER	1	PZ																															
			VI1220A1	4,2X12 TCB SELF-TAPPING SCREW	2	PZ																															
VL1014A0	PRESSURE REDUCER WITH DISTRIBUTOR	1	PZ																																		

COMPONENT			SPARE PART																																																			
Code	Description	Image	Code	Description	Components list																																																	
RC1372A	Ø10M-1/4 M CIL. STRAIGHT FITTING		KVL1117A	EU FILTER PRESSURE REDUCER KIT	<table border="1"> <thead> <tr> <th>Code</th> <th>Description</th> <th>Qty</th> <th>UOM</th> </tr> </thead> <tbody> <tr> <td>VL1014B0</td> <td>PRESSURE REDUCER WITH DISTRIBUTOR</td> <td>1</td> <td>PZ</td> </tr> <tr> <td>VL1034C0</td> <td></td> <td>1</td> <td>PZ</td> </tr> <tr> <td>VL1062C0</td> <td></td> <td>1</td> <td>PZ</td> </tr> <tr> <td>VM1053A0</td> <td>1/8" CAP + O-RING</td> <td>2</td> <td>PZ</td> </tr> <tr> <td>VM1054A0</td> <td>H7.8 PRESSURE REDUCER RING NUT</td> <td>1</td> <td>PZ</td> </tr> </tbody> </table>	Code	Description	Qty	UOM	VL1014B0	PRESSURE REDUCER WITH DISTRIBUTOR	1	PZ	VL1034C0		1	PZ	VL1062C0		1	PZ	VM1053A0	1/8" CAP + O-RING	2	PZ	VM1054A0	H7.8 PRESSURE REDUCER RING NUT	1	PZ																									
			Code	Description	Qty	UOM																																																
VL1014B0	PRESSURE REDUCER WITH DISTRIBUTOR	1	PZ																																																			
VL1034C0		1	PZ																																																			
VL1062C0		1	PZ																																																			
VM1053A0	1/8" CAP + O-RING	2	PZ																																																			
VM1054A0	H7.8 PRESSURE REDUCER RING NUT	1	PZ																																																			
KRC1372A	D 10M-1/4 M CIL STRAIGHT CONNECTION KIT	<table border="1"> <thead> <tr> <th>Code</th> <th>Description</th> <th>Qty</th> <th>UOM</th> </tr> </thead> <tbody> <tr> <td>RC1372A0</td> <td>Ø10M-1/4 M CIL. STRAIGHT FITTING</td> <td>1</td> <td>PZ</td> </tr> </tbody> </table>	Code	Description	Qty	UOM	RC1372A0	Ø10M-1/4 M CIL. STRAIGHT FITTING	1	PZ																																												
Code	Description	Qty	UOM																																																			
RC1372A0	Ø10M-1/4 M CIL. STRAIGHT FITTING	1	PZ																																																			
VM1054A	H7.8 PRESSURE REDUCER RING NUT		KVM1054A	H7.8 PRESSURE REDUCER DIAL KIT	<table border="1"> <thead> <tr> <th>Code</th> <th>Description</th> <th>Qty</th> <th>UOM</th> </tr> </thead> <tbody> <tr> <td>VM1054A0</td> <td>H7.8 PRESSURE REDUCER RING NUT</td> <td>1</td> <td>PZ</td> </tr> </tbody> </table>	Code	Description	Qty	UOM	VM1054A0	H7.8 PRESSURE REDUCER RING NUT	1	PZ																																									
			Code	Description	Qty	UOM																																																
VM1054A0	H7.8 PRESSURE REDUCER RING NUT	1	PZ																																																			
KVL1117A	EU FILTER PRESSURE REDUCER KIT	<table border="1"> <thead> <tr> <th>Code</th> <th>Description</th> <th>Qty</th> <th>UOM</th> </tr> </thead> <tbody> <tr> <td>0H7472A1</td> <td></td> <td>1</td> <td>PZ</td> </tr> <tr> <td>RC1004A0</td> <td>D10-D8-8 Y CONNECTION</td> <td>1</td> <td>PZ</td> </tr> <tr> <td>RC1243A0</td> <td>Ø10F-Ø10M ELBOW CONNECTION + JG END KIT</td> <td>1</td> <td>PZ</td> </tr> <tr> <td>RC1372A0</td> <td>Ø10M-1/4 M CIL. STRAIGHT FITTING</td> <td>2</td> <td>PZ</td> </tr> <tr> <td>VI1013A1</td> <td>30.5X39.5X3 NYLON FLAT WASHER</td> <td>1</td> <td>PZ</td> </tr> <tr> <td>VI1220A1</td> <td>4,2X12 TCB SELF-TAPPIN G SCREW</td> <td>2</td> <td>PZ</td> </tr> <tr> <td>VL1014A0</td> <td>PRESSURE REDUCER WITH DISTRIBUTOR</td> <td>1</td> <td>PZ</td> </tr> <tr> <td>VL1014B0</td> <td>PRESSURE REDUCER WITH DISTRIBUTOR</td> <td>1</td> <td>PZ</td> </tr> <tr> <td>VL1034C0</td> <td></td> <td>1</td> <td>PZ</td> </tr> <tr> <td>VL1062C0</td> <td></td> <td>1</td> <td>PZ</td> </tr> <tr> <td>VM1053A0</td> <td>1/8" CAP + O-RING</td> <td>2</td> <td>PZ</td> </tr> <tr> <td>VM1054A0</td> <td>H7.8 PRESSURE REDUCER RING NUT</td> <td>1</td> <td>PZ</td> </tr> </tbody> </table>	Code	Description	Qty	UOM	0H7472A1		1	PZ	RC1004A0	D10-D8-8 Y CONNECTION	1	PZ	RC1243A0	Ø10F-Ø10M ELBOW CONNECTION + JG END KIT	1	PZ	RC1372A0	Ø10M-1/4 M CIL. STRAIGHT FITTING	2	PZ	VI1013A1	30.5X39.5X3 NYLON FLAT WASHER	1	PZ	VI1220A1	4,2X12 TCB SELF-TAPPIN G SCREW	2	PZ	VL1014A0	PRESSURE REDUCER WITH DISTRIBUTOR	1	PZ	VL1014B0	PRESSURE REDUCER WITH DISTRIBUTOR	1	PZ	VL1034C0		1	PZ	VL1062C0		1	PZ	VM1053A0	1/8" CAP + O-RING	2	PZ	VM1054A0	H7.8 PRESSURE REDUCER RING NUT	1	PZ
Code	Description	Qty	UOM																																																			
0H7472A1		1	PZ																																																			
RC1004A0	D10-D8-8 Y CONNECTION	1	PZ																																																			
RC1243A0	Ø10F-Ø10M ELBOW CONNECTION + JG END KIT	1	PZ																																																			
RC1372A0	Ø10M-1/4 M CIL. STRAIGHT FITTING	2	PZ																																																			
VI1013A1	30.5X39.5X3 NYLON FLAT WASHER	1	PZ																																																			
VI1220A1	4,2X12 TCB SELF-TAPPIN G SCREW	2	PZ																																																			
VL1014A0	PRESSURE REDUCER WITH DISTRIBUTOR	1	PZ																																																			
VL1014B0	PRESSURE REDUCER WITH DISTRIBUTOR	1	PZ																																																			
VL1034C0		1	PZ																																																			
VL1062C0		1	PZ																																																			
VM1053A0	1/8" CAP + O-RING	2	PZ																																																			
VM1054A0	H7.8 PRESSURE REDUCER RING NUT	1	PZ																																																			

COMPONENT			SPARE PART																																																						
Code	Description	Image	Code	Description	Components list																																																				
RC1004A	D10-D8-8 Y CONNECTION		KVL1117A	EU FILTER PRESSURE REDUCER KIT	<table border="1"> <thead> <tr> <th>Code</th> <th>Description</th> <th>Qty</th> <th>UOM</th> </tr> </thead> <tbody> <tr> <td>0H7472A1</td> <td></td> <td>1</td> <td>PZ</td> </tr> <tr> <td>RC1004A0</td> <td>D10-D8-8 Y CONNECTION</td> <td>1</td> <td>PZ</td> </tr> <tr> <td>RC1243A0</td> <td>Ø10F-Ø10M ELBOW CONNECTION + JG END KIT</td> <td>1</td> <td>PZ</td> </tr> <tr> <td>RC1372A0</td> <td>Ø10M-1/4 M CIL. STRAIGHT FITTING</td> <td>2</td> <td>PZ</td> </tr> <tr> <td>VI1013A1</td> <td>30.5X39.5X3 NYLON FLAT WASHER</td> <td>1</td> <td>PZ</td> </tr> <tr> <td>VI1220A1</td> <td>4,2X12 TCB SELF-TAPPIN G SCREW</td> <td>2</td> <td>PZ</td> </tr> <tr> <td>VL1014A0</td> <td>PRESSURE REDUCER WITH DISTRIBUTOR</td> <td>1</td> <td>PZ</td> </tr> <tr> <td>VL1014B0</td> <td>PRESSURE REDUCER WITH DISTRIBUTOR</td> <td>1</td> <td>PZ</td> </tr> <tr> <td>VL1034C0</td> <td></td> <td>1</td> <td>PZ</td> </tr> <tr> <td>VL1062C0</td> <td></td> <td>1</td> <td>PZ</td> </tr> <tr> <td>VM1053A0</td> <td>1/8" CAP + O-RING</td> <td>2</td> <td>PZ</td> </tr> <tr> <td>VM1054A0</td> <td>H7.8 PRESSURE REDUCER RING NUT</td> <td>1</td> <td>PZ</td> </tr> </tbody> </table>	Code	Description	Qty	UOM	0H7472A1		1	PZ	RC1004A0	D10-D8-8 Y CONNECTION	1	PZ	RC1243A0	Ø10F-Ø10M ELBOW CONNECTION + JG END KIT	1	PZ	RC1372A0	Ø10M-1/4 M CIL. STRAIGHT FITTING	2	PZ	VI1013A1	30.5X39.5X3 NYLON FLAT WASHER	1	PZ	VI1220A1	4,2X12 TCB SELF-TAPPIN G SCREW	2	PZ	VL1014A0	PRESSURE REDUCER WITH DISTRIBUTOR	1	PZ	VL1014B0	PRESSURE REDUCER WITH DISTRIBUTOR	1	PZ	VL1034C0		1	PZ	VL1062C0		1	PZ	VM1053A0	1/8" CAP + O-RING	2	PZ	VM1054A0	H7.8 PRESSURE REDUCER RING NUT	1	PZ
					Code	Description	Qty	UOM																																																	
0H7472A1		1	PZ																																																						
RC1004A0	D10-D8-8 Y CONNECTION	1	PZ																																																						
RC1243A0	Ø10F-Ø10M ELBOW CONNECTION + JG END KIT	1	PZ																																																						
RC1372A0	Ø10M-1/4 M CIL. STRAIGHT FITTING	2	PZ																																																						
VI1013A1	30.5X39.5X3 NYLON FLAT WASHER	1	PZ																																																						
VI1220A1	4,2X12 TCB SELF-TAPPIN G SCREW	2	PZ																																																						
VL1014A0	PRESSURE REDUCER WITH DISTRIBUTOR	1	PZ																																																						
VL1014B0	PRESSURE REDUCER WITH DISTRIBUTOR	1	PZ																																																						
VL1034C0		1	PZ																																																						
VL1062C0		1	PZ																																																						
VM1053A0	1/8" CAP + O-RING	2	PZ																																																						
VM1054A0	H7.8 PRESSURE REDUCER RING NUT	1	PZ																																																						
			KRC1004A	10 PCS. Ø10-Ø8-8 Y FITTING KIT	<table border="1"> <thead> <tr> <th>Code</th> <th>Description</th> <th>Qty</th> <th>UOM</th> </tr> </thead> <tbody> <tr> <td>RC1004A0</td> <td>D10-D8-8 Y CONNECTION</td> <td>10</td> <td>PZ</td> </tr> </tbody> </table>	Code	Description	Qty	UOM	RC1004A0	D10-D8-8 Y CONNECTION	10	PZ																																												
Code	Description	Qty	UOM																																																						
RC1004A0	D10-D8-8 Y CONNECTION	10	PZ																																																						
VL1034C			KVL1117A	EU FILTER PRESSURE REDUCER KIT	<table border="1"> <thead> <tr> <th>Code</th> <th>Description</th> <th>Qty</th> <th>UOM</th> </tr> </thead> <tbody> <tr> <td>0H7472A1</td> <td></td> <td>1</td> <td>PZ</td> </tr> <tr> <td>RC1004A0</td> <td>D10-D8-8 Y CONNECTION</td> <td>1</td> <td>PZ</td> </tr> <tr> <td>RC1243A0</td> <td>Ø10F-Ø10M ELBOW CONNECTION + JG END KIT</td> <td>1</td> <td>PZ</td> </tr> <tr> <td>RC1372A0</td> <td>Ø10M-1/4 M CIL. STRAIGHT FITTING</td> <td>2</td> <td>PZ</td> </tr> <tr> <td>VI1013A1</td> <td>30.5X39.5X3 NYLON FLAT WASHER</td> <td>1</td> <td>PZ</td> </tr> <tr> <td>VI1220A1</td> <td>4,2X12 TCB SELF-TAPPIN G SCREW</td> <td>2</td> <td>PZ</td> </tr> </tbody> </table>	Code	Description	Qty	UOM	0H7472A1		1	PZ	RC1004A0	D10-D8-8 Y CONNECTION	1	PZ	RC1243A0	Ø10F-Ø10M ELBOW CONNECTION + JG END KIT	1	PZ	RC1372A0	Ø10M-1/4 M CIL. STRAIGHT FITTING	2	PZ	VI1013A1	30.5X39.5X3 NYLON FLAT WASHER	1	PZ	VI1220A1	4,2X12 TCB SELF-TAPPIN G SCREW	2	PZ																								
Code	Description	Qty	UOM																																																						
0H7472A1		1	PZ																																																						
RC1004A0	D10-D8-8 Y CONNECTION	1	PZ																																																						
RC1243A0	Ø10F-Ø10M ELBOW CONNECTION + JG END KIT	1	PZ																																																						
RC1372A0	Ø10M-1/4 M CIL. STRAIGHT FITTING	2	PZ																																																						
VI1013A1	30.5X39.5X3 NYLON FLAT WASHER	1	PZ																																																						
VI1220A1	4,2X12 TCB SELF-TAPPIN G SCREW	2	PZ																																																						

COMPONENT			SPARE PART																																																						
Code	Description	Image	Code	Description	Components list																																																				
VL1034C			KVL1117A	EU FILTER PRESSURE REDUCER KIT	<table border="1"> <thead> <tr> <th>Code</th> <th>Description</th> <th>Qty</th> <th>UOM</th> </tr> </thead> <tbody> <tr> <td>VL1014A0</td> <td>PRESSURE REDUCER WITH DISTRIBUTOR</td> <td>1</td> <td>PZ</td> </tr> <tr> <td>VL1014B0</td> <td>PRESSURE REDUCER WITH DISTRIBUTOR</td> <td>1</td> <td>PZ</td> </tr> <tr> <td>VL1034C0</td> <td></td> <td>1</td> <td>PZ</td> </tr> <tr> <td>VL1062C0</td> <td></td> <td>1</td> <td>PZ</td> </tr> <tr> <td>VM1053A0</td> <td>1/8" CAP + O-RING</td> <td>2</td> <td>PZ</td> </tr> <tr> <td>VM1054A0</td> <td>H7.8 PRESSURE REDUCER RING NUT</td> <td>1</td> <td>PZ</td> </tr> </tbody> </table>	Code	Description	Qty	UOM	VL1014A0	PRESSURE REDUCER WITH DISTRIBUTOR	1	PZ	VL1014B0	PRESSURE REDUCER WITH DISTRIBUTOR	1	PZ	VL1034C0		1	PZ	VL1062C0		1	PZ	VM1053A0	1/8" CAP + O-RING	2	PZ	VM1054A0	H7.8 PRESSURE REDUCER RING NUT	1	PZ																								
			Code	Description	Qty	UOM																																																			
VL1014A0	PRESSURE REDUCER WITH DISTRIBUTOR	1	PZ																																																						
VL1014B0	PRESSURE REDUCER WITH DISTRIBUTOR	1	PZ																																																						
VL1034C0		1	PZ																																																						
VL1062C0		1	PZ																																																						
VM1053A0	1/8" CAP + O-RING	2	PZ																																																						
VM1054A0	H7.8 PRESSURE REDUCER RING NUT	1	PZ																																																						
KVL1034C	Ø10 MESH100 WATER FILTER KIT	<table border="1"> <thead> <tr> <th>Code</th> <th>Description</th> <th>Qty</th> <th>UOM</th> </tr> </thead> <tbody> <tr> <td>RC1002A0</td> <td>JG 10M-8F TERMINAL REDUCTION FITTING</td> <td>2</td> <td>PZ</td> </tr> <tr> <td>VL1034C0</td> <td></td> <td>1</td> <td>PZ</td> </tr> <tr> <td>VL1062C0</td> <td></td> <td>1</td> <td>PZ</td> </tr> </tbody> </table>	Code	Description	Qty	UOM	RC1002A0	JG 10M-8F TERMINAL REDUCTION FITTING	2	PZ	VL1034C0		1	PZ	VL1062C0		1	PZ																																							
Code	Description	Qty	UOM																																																						
RC1002A0	JG 10M-8F TERMINAL REDUCTION FITTING	2	PZ																																																						
VL1034C0		1	PZ																																																						
VL1062C0		1	PZ																																																						
VL1062C			KVL1117A	EU FILTER PRESSURE REDUCER KIT	<table border="1"> <thead> <tr> <th>Code</th> <th>Description</th> <th>Qty</th> <th>UOM</th> </tr> </thead> <tbody> <tr> <td>0H7472A1</td> <td></td> <td>1</td> <td>PZ</td> </tr> <tr> <td>RC1004A0</td> <td>D10-D8-8 Y CONNECTION</td> <td>1</td> <td>PZ</td> </tr> <tr> <td>RC1243A0</td> <td>Ø10F-Ø10M ELBOW CONNECTION + JG END KIT</td> <td>1</td> <td>PZ</td> </tr> <tr> <td>RC1372A0</td> <td>Ø10M-1/4 M CIL. STRAIGHT FITTING</td> <td>2</td> <td>PZ</td> </tr> <tr> <td>VI1013A1</td> <td>30.5X39.5X3 NYLON FLAT WASHER</td> <td>1</td> <td>PZ</td> </tr> <tr> <td>VI1220A1</td> <td>4,2X12 TCB SELF-TAPPIN G SCREW</td> <td>2</td> <td>PZ</td> </tr> <tr> <td>VL1014A0</td> <td>PRESSURE REDUCER WITH DISTRIBUTOR</td> <td>1</td> <td>PZ</td> </tr> <tr> <td>VL1014B0</td> <td>PRESSURE REDUCER WITH DISTRIBUTOR</td> <td>1</td> <td>PZ</td> </tr> <tr> <td>VL1034C0</td> <td></td> <td>1</td> <td>PZ</td> </tr> <tr> <td>VL1062C0</td> <td></td> <td>1</td> <td>PZ</td> </tr> <tr> <td>VM1053A0</td> <td>1/8" CAP + O-RING</td> <td>2</td> <td>PZ</td> </tr> <tr> <td>VM1054A0</td> <td>H7.8 PRESSURE REDUCER RING NUT</td> <td>1</td> <td>PZ</td> </tr> </tbody> </table>	Code	Description	Qty	UOM	0H7472A1		1	PZ	RC1004A0	D10-D8-8 Y CONNECTION	1	PZ	RC1243A0	Ø10F-Ø10M ELBOW CONNECTION + JG END KIT	1	PZ	RC1372A0	Ø10M-1/4 M CIL. STRAIGHT FITTING	2	PZ	VI1013A1	30.5X39.5X3 NYLON FLAT WASHER	1	PZ	VI1220A1	4,2X12 TCB SELF-TAPPIN G SCREW	2	PZ	VL1014A0	PRESSURE REDUCER WITH DISTRIBUTOR	1	PZ	VL1014B0	PRESSURE REDUCER WITH DISTRIBUTOR	1	PZ	VL1034C0		1	PZ	VL1062C0		1	PZ	VM1053A0	1/8" CAP + O-RING	2	PZ	VM1054A0	H7.8 PRESSURE REDUCER RING NUT	1	PZ
			Code	Description	Qty	UOM																																																			
			0H7472A1		1	PZ																																																			
			RC1004A0	D10-D8-8 Y CONNECTION	1	PZ																																																			
			RC1243A0	Ø10F-Ø10M ELBOW CONNECTION + JG END KIT	1	PZ																																																			
			RC1372A0	Ø10M-1/4 M CIL. STRAIGHT FITTING	2	PZ																																																			
			VI1013A1	30.5X39.5X3 NYLON FLAT WASHER	1	PZ																																																			
			VI1220A1	4,2X12 TCB SELF-TAPPIN G SCREW	2	PZ																																																			
			VL1014A0	PRESSURE REDUCER WITH DISTRIBUTOR	1	PZ																																																			
			VL1014B0	PRESSURE REDUCER WITH DISTRIBUTOR	1	PZ																																																			
			VL1034C0		1	PZ																																																			
			VL1062C0		1	PZ																																																			
			VM1053A0	1/8" CAP + O-RING	2	PZ																																																			
VM1054A0	H7.8 PRESSURE REDUCER RING NUT	1	PZ																																																						





COMPONENT			SPARE PART																																																						
Code	Description	Image	Code	Description	Components list																																																				
0H7472A			K0H7472A	DISTRIBUTOR SUPPORT PLATE KI	<table border="1"> <thead> <tr> <th>Code</th> <th>Description</th> <th>Qty</th> <th>UOM</th> </tr> </thead> <tbody> <tr> <td>0H7472A0</td> <td></td> <td>1</td> <td>PZ</td> </tr> <tr> <td>0H7472A1</td> <td></td> <td>1</td> <td>PZ</td> </tr> </tbody> </table>	Code	Description	Qty	UOM	0H7472A0		1	PZ	0H7472A1		1	PZ																																								
Code	Description	Qty	UOM																																																						
0H7472A0		1	PZ																																																						
0H7472A1		1	PZ																																																						
VL1085A	3/4" VACUUM BREAKER																																																								
RC1405A																																																									
VL1019A	VIBRATION PUMP		KVL1109A	ONE DOUBLE ROTOR WASHING SYSTEM KIT	<table border="1"> <thead> <tr> <th>Code</th> <th>Description</th> <th>Qty</th> <th>UOM</th> </tr> </thead> <tbody> <tr> <td>0H7324A0</td> <td></td> <td>2</td> <td>PZ</td> </tr> <tr> <td>0H7515A0</td> <td></td> <td>1</td> <td>PZ</td> </tr> <tr> <td>CH1000A0</td> <td>SNIP PIPE CUTTER</td> <td>1</td> <td>PZ</td> </tr> <tr> <td>EL1115A0</td> <td>Ø8 Y CONNECTION</td> <td>1</td> <td>PZ</td> </tr> <tr> <td>EL1436A0</td> <td></td> <td>2</td> <td>PZ</td> </tr> <tr> <td>GN1526A0</td> <td>INT. D.=6.9 TH=1.8 O-RIN</td> <td>2</td> <td>PZ</td> </tr> <tr> <td>RC1006A0</td> <td>D8 PET PIPE GUIDE BEND</td> <td>4</td> <td>PZ</td> </tr> <tr> <td>RC1019A0</td> <td>D=10 ELASTIC CLAMP</td> <td>30</td> <td>PZ</td> </tr> <tr> <td>RC1242A0</td> <td>D=10 CLOSED CAP</td> <td>4</td> <td>PZ</td> </tr> <tr> <td>TB1818A0</td> <td>8X4.75 BLUE PE WATER INLET PIPE</td> <td>1.640</td> <td>M</td> </tr> <tr> <td>TB2820A0</td> <td>PIPE EPDM FOR WASHING SYSTEM</td> <td>2.760</td> <td>M</td> </tr> <tr> <td>VI1220A1</td> <td>4,2X12 TCB SELF-TAPPIN G SCREW</td> <td>8</td> <td>PZ</td> </tr> </tbody> </table>	Code	Description	Qty	UOM	0H7324A0		2	PZ	0H7515A0		1	PZ	CH1000A0	SNIP PIPE CUTTER	1	PZ	EL1115A0	Ø8 Y CONNECTION	1	PZ	EL1436A0		2	PZ	GN1526A0	INT. D.=6.9 TH=1.8 O-RIN	2	PZ	RC1006A0	D8 PET PIPE GUIDE BEND	4	PZ	RC1019A0	D=10 ELASTIC CLAMP	30	PZ	RC1242A0	D=10 CLOSED CAP	4	PZ	TB1818A0	8X4.75 BLUE PE WATER INLET PIPE	1.640	M	TB2820A0	PIPE EPDM FOR WASHING SYSTEM	2.760	M	VI1220A1	4,2X12 TCB SELF-TAPPIN G SCREW	8	PZ
Code	Description	Qty	UOM																																																						
0H7324A0		2	PZ																																																						
0H7515A0		1	PZ																																																						
CH1000A0	SNIP PIPE CUTTER	1	PZ																																																						
EL1115A0	Ø8 Y CONNECTION	1	PZ																																																						
EL1436A0		2	PZ																																																						
GN1526A0	INT. D.=6.9 TH=1.8 O-RIN	2	PZ																																																						
RC1006A0	D8 PET PIPE GUIDE BEND	4	PZ																																																						
RC1019A0	D=10 ELASTIC CLAMP	30	PZ																																																						
RC1242A0	D=10 CLOSED CAP	4	PZ																																																						
TB1818A0	8X4.75 BLUE PE WATER INLET PIPE	1.640	M																																																						
TB2820A0	PIPE EPDM FOR WASHING SYSTEM	2.760	M																																																						
VI1220A1	4,2X12 TCB SELF-TAPPIN G SCREW	8	PZ																																																						

COMPONENT			SPARE PART																																																																			
Code	Description	Image	Code	Description	Components list																																																																	
VL1019A	VIBRATION PUMP		KVL1109A	ONE DOUBLE ROTOR WASHING SYSTEM KIT	<table border="1"> <thead> <tr> <th>Code</th> <th>Description</th> <th>Qty</th> <th>UOM</th> </tr> </thead> <tbody> <tr> <td>VL1019A0</td> <td>VIBRATION PUMP</td> <td>2</td> <td>PZ</td> </tr> <tr> <td>VL1053B0</td> <td></td> <td>2</td> <td>PZ</td> </tr> <tr> <td>VL1054B0</td> <td></td> <td>2</td> <td>PZ</td> </tr> <tr> <td>VL1080A0</td> <td>DETERGENT FILTER</td> <td>2</td> <td>PZ</td> </tr> <tr> <td>VL1081A0</td> <td>D6 BARBED NO RETURN VALVE</td> <td>4</td> <td>PZ</td> </tr> <tr> <td>VL1102A0</td> <td></td> <td>2</td> <td>PZ</td> </tr> <tr> <td>VM2172A0</td> <td>PUMP LOCKING CLIP</td> <td>2</td> <td>PZ</td> </tr> </tbody> </table>	Code	Description	Qty	UOM	VL1019A0	VIBRATION PUMP	2	PZ	VL1053B0		2	PZ	VL1054B0		2	PZ	VL1080A0	DETERGENT FILTER	2	PZ	VL1081A0	D6 BARBED NO RETURN VALVE	4	PZ	VL1102A0		2	PZ	VM2172A0	PUMP LOCKING CLIP	2	PZ																																	
			Code	Description	Qty	UOM																																																																
VL1019A0	VIBRATION PUMP	2	PZ																																																																			
VL1053B0		2	PZ																																																																			
VL1054B0		2	PZ																																																																			
VL1080A0	DETERGENT FILTER	2	PZ																																																																			
VL1081A0	D6 BARBED NO RETURN VALVE	4	PZ																																																																			
VL1102A0		2	PZ																																																																			
VM2172A0	PUMP LOCKING CLIP	2	PZ																																																																			
KVL1108A	ONE 04EU SINGLE ROTOR WASHING SYSTEM KIT	<table border="1"> <thead> <tr> <th>Code</th> <th>Description</th> <th>Qty</th> <th>UOM</th> </tr> </thead> <tbody> <tr> <td>0H7323A0</td> <td>WASHING SYSTEM HOLDING PLATE</td> <td>1</td> <td>PZ</td> </tr> <tr> <td>0H7511A0</td> <td></td> <td>1</td> <td>PZ</td> </tr> <tr> <td>EL1252A1</td> <td>1 WAY WATER VALVE + J.G. CONNECTION</td> <td>1</td> <td>PZ</td> </tr> <tr> <td>EL1424A0</td> <td>D8 CONNECTION WATER SOLENOID VALVE</td> <td>1</td> <td>PZ</td> </tr> <tr> <td>EL1436A0</td> <td></td> <td>1</td> <td>PZ</td> </tr> <tr> <td>GN1526A0</td> <td>INT. D.=6.9 TH=1.8 O-RIN</td> <td>1</td> <td>PZ</td> </tr> <tr> <td>RC1019A0</td> <td>D=10 ELASTIC CLAMP</td> <td>11</td> <td>PZ</td> </tr> <tr> <td>RC1130A0</td> <td>130X2,6 CLAM</td> <td>1</td> <td>PZ</td> </tr> <tr> <td>RC1242A0</td> <td>D=10 CLOSED CAP</td> <td>2</td> <td>PZ</td> </tr> <tr> <td>RC1310A0</td> <td>140X4 CLAMP WITH CLIP</td> <td>2</td> <td>PZ</td> </tr> <tr> <td>RC1356A0</td> <td>STRAIGHT THREADED FEMALE END 8X1/4" BSP</td> <td>1</td> <td>PZ</td> </tr> <tr> <td>TB1818A0</td> <td>8X4.75 BLUE PE WATER INLET PIPE</td> <td>0.220</td> <td>M</td> </tr> <tr> <td>TB2820A0</td> <td>PIPE EPDM FOR WASHING SYSTEM</td> <td>1.240</td> <td>M</td> </tr> <tr> <td>VI1220A1</td> <td>4,2X12 TCB SELF-TAPPIN G SCREW</td> <td>2</td> <td>PZ</td> </tr> <tr> <td>VL1019A0</td> <td>VIBRATION PUMP</td> <td>1</td> <td>PZ</td> </tr> <tr> <td>VL1064A0</td> <td>WASHING SYSTEM OUTLETS DISTRIBUTOR</td> <td>1</td> <td>PZ</td> </tr> </tbody> </table>	Code	Description	Qty	UOM	0H7323A0	WASHING SYSTEM HOLDING PLATE	1	PZ	0H7511A0		1	PZ	EL1252A1	1 WAY WATER VALVE + J.G. CONNECTION	1	PZ	EL1424A0	D8 CONNECTION WATER SOLENOID VALVE	1	PZ	EL1436A0		1	PZ	GN1526A0	INT. D.=6.9 TH=1.8 O-RIN	1	PZ	RC1019A0	D=10 ELASTIC CLAMP	11	PZ	RC1130A0	130X2,6 CLAM	1	PZ	RC1242A0	D=10 CLOSED CAP	2	PZ	RC1310A0	140X4 CLAMP WITH CLIP	2	PZ	RC1356A0	STRAIGHT THREADED FEMALE END 8X1/4" BSP	1	PZ	TB1818A0	8X4.75 BLUE PE WATER INLET PIPE	0.220	M	TB2820A0	PIPE EPDM FOR WASHING SYSTEM	1.240	M	VI1220A1	4,2X12 TCB SELF-TAPPIN G SCREW	2	PZ	VL1019A0	VIBRATION PUMP	1	PZ	VL1064A0	WASHING SYSTEM OUTLETS DISTRIBUTOR	1	PZ
Code	Description	Qty	UOM																																																																			
0H7323A0	WASHING SYSTEM HOLDING PLATE	1	PZ																																																																			
0H7511A0		1	PZ																																																																			
EL1252A1	1 WAY WATER VALVE + J.G. CONNECTION	1	PZ																																																																			
EL1424A0	D8 CONNECTION WATER SOLENOID VALVE	1	PZ																																																																			
EL1436A0		1	PZ																																																																			
GN1526A0	INT. D.=6.9 TH=1.8 O-RIN	1	PZ																																																																			
RC1019A0	D=10 ELASTIC CLAMP	11	PZ																																																																			
RC1130A0	130X2,6 CLAM	1	PZ																																																																			
RC1242A0	D=10 CLOSED CAP	2	PZ																																																																			
RC1310A0	140X4 CLAMP WITH CLIP	2	PZ																																																																			
RC1356A0	STRAIGHT THREADED FEMALE END 8X1/4" BSP	1	PZ																																																																			
TB1818A0	8X4.75 BLUE PE WATER INLET PIPE	0.220	M																																																																			
TB2820A0	PIPE EPDM FOR WASHING SYSTEM	1.240	M																																																																			
VI1220A1	4,2X12 TCB SELF-TAPPIN G SCREW	2	PZ																																																																			
VL1019A0	VIBRATION PUMP	1	PZ																																																																			
VL1064A0	WASHING SYSTEM OUTLETS DISTRIBUTOR	1	PZ																																																																			







COMPONENT			SPARE PART																																																							
Code	Description	Image	Code	Description	Components list																																																					
VL1019A	VIBRATION PUMP		KVL1108A	ONE 04EU SINGLE ROTOR WASHING SYSTEM KIT	<table border="1"> <thead> <tr> <th>Code</th> <th>Description</th> <th>Qty</th> <th>UOM</th> </tr> </thead> <tbody> <tr> <td>VL1065A1</td> <td>1/4 MALE N.O. PRESSURE SWITCH</td> <td>1</td> <td>PZ</td> </tr> <tr> <td>VL1067A0</td> <td>WASHING SYSTEM INLETS DISTRIBUTOR</td> <td>1</td> <td>PZ</td> </tr> <tr> <td>VL1080A0</td> <td>DETERGENT FILTER</td> <td>1</td> <td>PZ</td> </tr> <tr> <td>VL1081A0</td> <td>D6 BARBED NO RETURN VALVE</td> <td>2</td> <td>PZ</td> </tr> <tr> <td>VL1083A0</td> <td>D=10 CONNECTION - D=6 PIPE FITTING</td> <td>1</td> <td>PZ</td> </tr> <tr> <td>VL1102A0</td> <td></td> <td>1</td> <td>PZ</td> </tr> <tr> <td>VM2172A0</td> <td>PUMP LOCKING CLIP</td> <td>1</td> <td>PZ</td> </tr> </tbody> </table>	Code	Description	Qty	UOM	VL1065A1	1/4 MALE N.O. PRESSURE SWITCH	1	PZ	VL1067A0	WASHING SYSTEM INLETS DISTRIBUTOR	1	PZ	VL1080A0	DETERGENT FILTER	1	PZ	VL1081A0	D6 BARBED NO RETURN VALVE	2	PZ	VL1083A0	D=10 CONNECTION - D=6 PIPE FITTING	1	PZ	VL1102A0		1	PZ	VM2172A0	PUMP LOCKING CLIP	1	PZ																					
			Code	Description	Qty	UOM																																																				
VL1065A1	1/4 MALE N.O. PRESSURE SWITCH	1	PZ																																																							
VL1067A0	WASHING SYSTEM INLETS DISTRIBUTOR	1	PZ																																																							
VL1080A0	DETERGENT FILTER	1	PZ																																																							
VL1081A0	D6 BARBED NO RETURN VALVE	2	PZ																																																							
VL1083A0	D=10 CONNECTION - D=6 PIPE FITTING	1	PZ																																																							
VL1102A0		1	PZ																																																							
VM2172A0	PUMP LOCKING CLIP	1	PZ																																																							
KVL1107A	PLUS 04EU SINGLE ROTOR WASHING KI	<table border="1"> <thead> <tr> <th>Code</th> <th>Description</th> <th>Qty</th> <th>UOM</th> </tr> </thead> <tbody> <tr> <td>0H7323A0</td> <td>WASHING SYSTEM HOLDING PLATE</td> <td>1</td> <td>PZ</td> </tr> <tr> <td>EL1252A1</td> <td>1 WAY WATER VALVE + J.G. CONNECTION</td> <td>1</td> <td>PZ</td> </tr> <tr> <td>EL1424A0</td> <td>D8 CONNECTION WATER SOLENOID VALVE</td> <td>1</td> <td>PZ</td> </tr> <tr> <td>EL1436A0</td> <td></td> <td>1</td> <td>PZ</td> </tr> <tr> <td>GN1526A0</td> <td>INT. D.=6.9 TH=1.8 O-RING</td> <td>1</td> <td>PZ</td> </tr> <tr> <td>RC1019A0</td> <td>D=10 ELASTIC CLAMP</td> <td>11</td> <td>PZ</td> </tr> <tr> <td>RC1130A0</td> <td>130X2,6 CLAMP</td> <td>1</td> <td>PZ</td> </tr> <tr> <td>RC1242A0</td> <td>D=10 CLOSED CAP</td> <td>2</td> <td>PZ</td> </tr> <tr> <td>RC1310A0</td> <td>140X4 CLAMP WITH CLIP</td> <td>2</td> <td>PZ</td> </tr> <tr> <td>RC1356A0</td> <td>STRAIGHT THREADED FEMALE END 8X1/4" BSP</td> <td>1</td> <td>PZ</td> </tr> <tr> <td>TB2820A0</td> <td>PIPE EPDM FOR WASHING SYSTEM</td> <td>2.040</td> <td>M</td> </tr> <tr> <td>VI1220A1</td> <td>4,2X12 TCB SELF-TAPPING SCREW</td> <td>2</td> <td>PZ</td> </tr> <tr> <td>VL1019A0</td> <td>VIBRATION PUMP</td> <td>1</td> <td>PZ</td> </tr> </tbody> </table>	Code	Description	Qty	UOM	0H7323A0	WASHING SYSTEM HOLDING PLATE	1	PZ	EL1252A1	1 WAY WATER VALVE + J.G. CONNECTION	1	PZ	EL1424A0	D8 CONNECTION WATER SOLENOID VALVE	1	PZ	EL1436A0		1	PZ	GN1526A0	INT. D.=6.9 TH=1.8 O-RING	1	PZ	RC1019A0	D=10 ELASTIC CLAMP	11	PZ	RC1130A0	130X2,6 CLAMP	1	PZ	RC1242A0	D=10 CLOSED CAP	2	PZ	RC1310A0	140X4 CLAMP WITH CLIP	2	PZ	RC1356A0	STRAIGHT THREADED FEMALE END 8X1/4" BSP	1	PZ	TB2820A0	PIPE EPDM FOR WASHING SYSTEM	2.040	M	VI1220A1	4,2X12 TCB SELF-TAPPING SCREW	2	PZ	VL1019A0	VIBRATION PUMP	1	PZ
Code	Description	Qty	UOM																																																							
0H7323A0	WASHING SYSTEM HOLDING PLATE	1	PZ																																																							
EL1252A1	1 WAY WATER VALVE + J.G. CONNECTION	1	PZ																																																							
EL1424A0	D8 CONNECTION WATER SOLENOID VALVE	1	PZ																																																							
EL1436A0		1	PZ																																																							
GN1526A0	INT. D.=6.9 TH=1.8 O-RING	1	PZ																																																							
RC1019A0	D=10 ELASTIC CLAMP	11	PZ																																																							
RC1130A0	130X2,6 CLAMP	1	PZ																																																							
RC1242A0	D=10 CLOSED CAP	2	PZ																																																							
RC1310A0	140X4 CLAMP WITH CLIP	2	PZ																																																							
RC1356A0	STRAIGHT THREADED FEMALE END 8X1/4" BSP	1	PZ																																																							
TB2820A0	PIPE EPDM FOR WASHING SYSTEM	2.040	M																																																							
VI1220A1	4,2X12 TCB SELF-TAPPING SCREW	2	PZ																																																							
VL1019A0	VIBRATION PUMP	1	PZ																																																							

COMPONENT			SPARE PART																																																																			
Code	Description	Image	Code	Description	Components list																																																																	
VL1019A	VIBRATION PUMP		KVL1107A	PLUS 04EU SINGLE ROTOR WASHING KI	<table border="1"> <thead> <tr> <th>Code</th> <th>Description</th> <th>Qty</th> <th>UOM</th> </tr> </thead> <tbody> <tr> <td>VL1064A0</td> <td>WASHING SYSTEM OUTLETS DISTRIBUTOR</td> <td>1</td> <td>PZ</td> </tr> <tr> <td>VL1065A1</td> <td>1/4 MALE N.O. PRESSURE SWITCH</td> <td>1</td> <td>PZ</td> </tr> <tr> <td>VL1067A0</td> <td>WASHING SYSTEM INLETS DISTRIBUTOR</td> <td>1</td> <td>PZ</td> </tr> <tr> <td>VL1080A0</td> <td>DETERGENT FILTER</td> <td>1</td> <td>PZ</td> </tr> <tr> <td>VL1081A0</td> <td>D6 BARBED NO RETURN VALVE</td> <td>2</td> <td>PZ</td> </tr> <tr> <td>VL1083A0</td> <td>D=10 CONNECTION - D=6 PIPE FITTING</td> <td>1</td> <td>PZ</td> </tr> <tr> <td>VL1102A0</td> <td></td> <td>1</td> <td>PZ</td> </tr> <tr> <td>VM2172A0</td> <td>PUMP LOCKING CLIP</td> <td>1</td> <td>PZ</td> </tr> </tbody> </table>	Code	Description	Qty	UOM	VL1064A0	WASHING SYSTEM OUTLETS DISTRIBUTOR	1	PZ	VL1065A1	1/4 MALE N.O. PRESSURE SWITCH	1	PZ	VL1067A0	WASHING SYSTEM INLETS DISTRIBUTOR	1	PZ	VL1080A0	DETERGENT FILTER	1	PZ	VL1081A0	D6 BARBED NO RETURN VALVE	2	PZ	VL1083A0	D=10 CONNECTION - D=6 PIPE FITTING	1	PZ	VL1102A0		1	PZ	VM2172A0	PUMP LOCKING CLIP	1	PZ																													
			Code	Description	Qty	UOM																																																																
VL1064A0	WASHING SYSTEM OUTLETS DISTRIBUTOR	1	PZ																																																																			
VL1065A1	1/4 MALE N.O. PRESSURE SWITCH	1	PZ																																																																			
VL1067A0	WASHING SYSTEM INLETS DISTRIBUTOR	1	PZ																																																																			
VL1080A0	DETERGENT FILTER	1	PZ																																																																			
VL1081A0	D6 BARBED NO RETURN VALVE	2	PZ																																																																			
VL1083A0	D=10 CONNECTION - D=6 PIPE FITTING	1	PZ																																																																			
VL1102A0		1	PZ																																																																			
VM2172A0	PUMP LOCKING CLIP	1	PZ																																																																			
KVL1106A	ONE EU WASHING SYSTEM SINGLE ROTOR KIT	<table border="1"> <thead> <tr> <th>Code</th> <th>Description</th> <th>Qty</th> <th>UOM</th> </tr> </thead> <tbody> <tr> <td>0H7324A0</td> <td></td> <td>1</td> <td>PZ</td> </tr> <tr> <td>EL1436A0</td> <td></td> <td>1</td> <td>PZ</td> </tr> <tr> <td>GN1526A0</td> <td>INT. D.=6.9 TH=1.8 O-RIN</td> <td>1</td> <td>PZ</td> </tr> <tr> <td>RC1006A0</td> <td>D8 PET PIPE GUIDE BEND</td> <td>2</td> <td>PZ</td> </tr> <tr> <td>RC1019A0</td> <td>D=10 ELASTIC CLAMP</td> <td>15</td> <td>PZ</td> </tr> <tr> <td>RC1242A0</td> <td>D=10 CLOSED CAP</td> <td>2</td> <td>PZ</td> </tr> <tr> <td>TB1818A0</td> <td>8X4.75 BLUE PE WATER INLET PIPE</td> <td>0.320</td> <td>M</td> </tr> <tr> <td>TB2820A0</td> <td>PIPE EPDM FOR WASHING SYSTEM</td> <td>1.380</td> <td>M</td> </tr> <tr> <td>VI1220A1</td> <td>4,2X12 TCB SELF-TAPPIN G SCREW</td> <td>1</td> <td>PZ</td> </tr> <tr> <td>VL1019A0</td> <td>VIBRATION PUMP</td> <td>1</td> <td>PZ</td> </tr> <tr> <td>VL1053B0</td> <td></td> <td>1</td> <td>PZ</td> </tr> <tr> <td>VL1054B0</td> <td></td> <td>1</td> <td>PZ</td> </tr> <tr> <td>VL1080A0</td> <td>DETERGENT FILTER</td> <td>1</td> <td>PZ</td> </tr> <tr> <td>VL1081A0</td> <td>D6 BARBED NO RETURN VALVE</td> <td>1</td> <td>PZ</td> </tr> <tr> <td>VL1102A0</td> <td></td> <td>1</td> <td>PZ</td> </tr> <tr> <td>VM2172A0</td> <td>PUMP LOCKING CLIP</td> <td>1</td> <td>PZ</td> </tr> </tbody> </table>	Code	Description	Qty	UOM	0H7324A0		1	PZ	EL1436A0		1	PZ	GN1526A0	INT. D.=6.9 TH=1.8 O-RIN	1	PZ	RC1006A0	D8 PET PIPE GUIDE BEND	2	PZ	RC1019A0	D=10 ELASTIC CLAMP	15	PZ	RC1242A0	D=10 CLOSED CAP	2	PZ	TB1818A0	8X4.75 BLUE PE WATER INLET PIPE	0.320	M	TB2820A0	PIPE EPDM FOR WASHING SYSTEM	1.380	M	VI1220A1	4,2X12 TCB SELF-TAPPIN G SCREW	1	PZ	VL1019A0	VIBRATION PUMP	1	PZ	VL1053B0		1	PZ	VL1054B0		1	PZ	VL1080A0	DETERGENT FILTER	1	PZ	VL1081A0	D6 BARBED NO RETURN VALVE	1	PZ	VL1102A0		1	PZ	VM2172A0	PUMP LOCKING CLIP	1	PZ
Code	Description	Qty	UOM																																																																			
0H7324A0		1	PZ																																																																			
EL1436A0		1	PZ																																																																			
GN1526A0	INT. D.=6.9 TH=1.8 O-RIN	1	PZ																																																																			
RC1006A0	D8 PET PIPE GUIDE BEND	2	PZ																																																																			
RC1019A0	D=10 ELASTIC CLAMP	15	PZ																																																																			
RC1242A0	D=10 CLOSED CAP	2	PZ																																																																			
TB1818A0	8X4.75 BLUE PE WATER INLET PIPE	0.320	M																																																																			
TB2820A0	PIPE EPDM FOR WASHING SYSTEM	1.380	M																																																																			
VI1220A1	4,2X12 TCB SELF-TAPPIN G SCREW	1	PZ																																																																			
VL1019A0	VIBRATION PUMP	1	PZ																																																																			
VL1053B0		1	PZ																																																																			
VL1054B0		1	PZ																																																																			
VL1080A0	DETERGENT FILTER	1	PZ																																																																			
VL1081A0	D6 BARBED NO RETURN VALVE	1	PZ																																																																			
VL1102A0		1	PZ																																																																			
VM2172A0	PUMP LOCKING CLIP	1	PZ																																																																			

COMPONENT			SPARE PART																																																																																						
Code	Description	Image	Code	Description	Components list																																																																																				
VL1019A	VIBRATION PUMP		KVL1105A		<table border="1"> <thead> <tr> <th>Code</th> <th>Description</th> <th>Qty</th> <th>UOM</th> </tr> </thead> <tbody> <tr> <td>0H7323A0</td> <td>WASHING SYSTEM HOLDING PLATE</td> <td>1</td> <td>PZ</td> </tr> <tr> <td>EL1020A1</td> <td></td> <td>1</td> <td>PZ</td> </tr> <tr> <td>EL1422A0</td> <td>1 WAY SOLENOID VALVE + D8-D10 REDUCTION</td> <td>1</td> <td>PZ</td> </tr> <tr> <td>EL1422A1</td> <td>1 WAY SOLENOID VALVE + D8-D10 REDUCTION</td> <td>1</td> <td>PZ</td> </tr> <tr> <td>EL1426A0</td> <td>SOLENOID</td> <td>2</td> <td>PZ</td> </tr> <tr> <td>EL1437A0</td> <td></td> <td>1</td> <td>PZ</td> </tr> <tr> <td>GN1526A0</td> <td>INT. D.=6.9 TH=1.8 O-RIN</td> <td>1</td> <td>PZ</td> </tr> <tr> <td>RC1019A0</td> <td>D=10 ELASTIC CLAMP</td> <td>12</td> <td>PZ</td> </tr> <tr> <td>RC1130A0</td> <td>130X2,6 CLAM</td> <td>1</td> <td>PZ</td> </tr> <tr> <td>RC1242A0</td> <td>D=10 CLOSED CAP</td> <td>2</td> <td>PZ</td> </tr> <tr> <td>RC1310A0</td> <td>140X4 CLAMP WITH CLIP</td> <td>2</td> <td>PZ</td> </tr> <tr> <td>RC1356A0</td> <td>STRAIGHT THREADED FEMALE END 8X1/4" BSP</td> <td>1</td> <td>PZ</td> </tr> <tr> <td>TB1818A0</td> <td>8X4.75 BLUE PE WATER INLET PIPE</td> <td>0.300</td> <td>M</td> </tr> <tr> <td>TB2820A0</td> <td>PIPE EPDM FOR WASHING SYSTEM</td> <td>2.040</td> <td>M</td> </tr> <tr> <td>VI1220A1</td> <td>4,2X12 TCB SELF-TAPPIN G SCREW</td> <td>2</td> <td>PZ</td> </tr> <tr> <td>VL1019A0</td> <td>VIBRATION PUMP</td> <td>1</td> <td>PZ</td> </tr> <tr> <td>VL1065A1</td> <td>1/4 MALE N.O. PRESSURE SWITCH</td> <td>1</td> <td>PZ</td> </tr> <tr> <td>VL1067A0</td> <td>WASHING SYSTEM INLETS DISTRIBUTOR</td> <td>1</td> <td>PZ</td> </tr> <tr> <td>VL1080A0</td> <td>DETERGENT FILTER</td> <td>1</td> <td>PZ</td> </tr> <tr> <td>VL1081A0</td> <td>D6 BARBED NO RETURN VALVE</td> <td>2</td> <td>PZ</td> </tr> </tbody> </table>	Code	Description	Qty	UOM	0H7323A0	WASHING SYSTEM HOLDING PLATE	1	PZ	EL1020A1		1	PZ	EL1422A0	1 WAY SOLENOID VALVE + D8-D10 REDUCTION	1	PZ	EL1422A1	1 WAY SOLENOID VALVE + D8-D10 REDUCTION	1	PZ	EL1426A0	SOLENOID	2	PZ	EL1437A0		1	PZ	GN1526A0	INT. D.=6.9 TH=1.8 O-RIN	1	PZ	RC1019A0	D=10 ELASTIC CLAMP	12	PZ	RC1130A0	130X2,6 CLAM	1	PZ	RC1242A0	D=10 CLOSED CAP	2	PZ	RC1310A0	140X4 CLAMP WITH CLIP	2	PZ	RC1356A0	STRAIGHT THREADED FEMALE END 8X1/4" BSP	1	PZ	TB1818A0	8X4.75 BLUE PE WATER INLET PIPE	0.300	M	TB2820A0	PIPE EPDM FOR WASHING SYSTEM	2.040	M	VI1220A1	4,2X12 TCB SELF-TAPPIN G SCREW	2	PZ	VL1019A0	VIBRATION PUMP	1	PZ	VL1065A1	1/4 MALE N.O. PRESSURE SWITCH	1	PZ	VL1067A0	WASHING SYSTEM INLETS DISTRIBUTOR	1	PZ	VL1080A0	DETERGENT FILTER	1	PZ	VL1081A0	D6 BARBED NO RETURN VALVE	2	PZ
Code	Description	Qty	UOM																																																																																						
0H7323A0	WASHING SYSTEM HOLDING PLATE	1	PZ																																																																																						
EL1020A1		1	PZ																																																																																						
EL1422A0	1 WAY SOLENOID VALVE + D8-D10 REDUCTION	1	PZ																																																																																						
EL1422A1	1 WAY SOLENOID VALVE + D8-D10 REDUCTION	1	PZ																																																																																						
EL1426A0	SOLENOID	2	PZ																																																																																						
EL1437A0		1	PZ																																																																																						
GN1526A0	INT. D.=6.9 TH=1.8 O-RIN	1	PZ																																																																																						
RC1019A0	D=10 ELASTIC CLAMP	12	PZ																																																																																						
RC1130A0	130X2,6 CLAM	1	PZ																																																																																						
RC1242A0	D=10 CLOSED CAP	2	PZ																																																																																						
RC1310A0	140X4 CLAMP WITH CLIP	2	PZ																																																																																						
RC1356A0	STRAIGHT THREADED FEMALE END 8X1/4" BSP	1	PZ																																																																																						
TB1818A0	8X4.75 BLUE PE WATER INLET PIPE	0.300	M																																																																																						
TB2820A0	PIPE EPDM FOR WASHING SYSTEM	2.040	M																																																																																						
VI1220A1	4,2X12 TCB SELF-TAPPIN G SCREW	2	PZ																																																																																						
VL1019A0	VIBRATION PUMP	1	PZ																																																																																						
VL1065A1	1/4 MALE N.O. PRESSURE SWITCH	1	PZ																																																																																						
VL1067A0	WASHING SYSTEM INLETS DISTRIBUTOR	1	PZ																																																																																						
VL1080A0	DETERGENT FILTER	1	PZ																																																																																						
VL1081A0	D6 BARBED NO RETURN VALVE	2	PZ																																																																																						





COMPONENT			SPARE PART																																																																						
Code	Description	Image	Code	Description	Components list																																																																				
VL1019A	VIBRATION PUMP		KVL1105A		<table border="1"> <thead> <tr> <th>Code</th> <th>Description</th> <th>Qty</th> <th>UOM</th> </tr> </thead> <tbody> <tr> <td>VL1083A0</td> <td>D=10 CONNECTION - D=6 PIPE FITTING</td> <td>1</td> <td>PZ</td> </tr> <tr> <td>VL1092A0</td> <td>WASHING SYSTEM OUTLET DOUBLE DISTRIBUTOR</td> <td>1</td> <td>PZ</td> </tr> <tr> <td>VM2172A0</td> <td>PUMP LOCKING CLIP</td> <td>1</td> <td>PZ</td> </tr> </tbody> </table>	Code	Description	Qty	UOM	VL1083A0	D=10 CONNECTION - D=6 PIPE FITTING	1	PZ	VL1092A0	WASHING SYSTEM OUTLET DOUBLE DISTRIBUTOR	1	PZ	VM2172A0	PUMP LOCKING CLIP	1	PZ																																																				
Code	Description	Qty	UOM																																																																						
VL1083A0	D=10 CONNECTION - D=6 PIPE FITTING	1	PZ																																																																						
VL1092A0	WASHING SYSTEM OUTLET DOUBLE DISTRIBUTOR	1	PZ																																																																						
VM2172A0	PUMP LOCKING CLIP	1	PZ																																																																						
			KVL1104A		<table border="1"> <thead> <tr> <th>Code</th> <th>Description</th> <th>Qty</th> <th>UOM</th> </tr> </thead> <tbody> <tr> <td>0H7323A0</td> <td>WASHING SYSTEM HOLDING PLATE</td> <td>1</td> <td>PZ</td> </tr> <tr> <td>EL1020A1</td> <td></td> <td>1</td> <td>PZ</td> </tr> <tr> <td>EL1422A0</td> <td>1 WAY SOLENOID VALVE + D8-D10 REDUCTION</td> <td>1</td> <td>PZ</td> </tr> <tr> <td>EL1422A1</td> <td>1 WAY SOLENOID VALVE + D8-D10 REDUCTION</td> <td>1</td> <td>PZ</td> </tr> <tr> <td>EL1426A0</td> <td>SOLENOID</td> <td>1</td> <td>PZ</td> </tr> <tr> <td>EL1437A0</td> <td></td> <td>1</td> <td>PZ</td> </tr> <tr> <td>GN1526A0</td> <td>INT. D.=6.9 TH=1.8 O-RING</td> <td>1</td> <td>PZ</td> </tr> <tr> <td>RC1019A0</td> <td>D=10 ELASTIC CLAMP</td> <td>11</td> <td>PZ</td> </tr> <tr> <td>RC1130A0</td> <td>130X2,6 CLAM</td> <td>1</td> <td>PZ</td> </tr> <tr> <td>RC1242A0</td> <td>D=10 CLOSED CAP</td> <td>2</td> <td>PZ</td> </tr> <tr> <td>RC1310A0</td> <td>140X4 CLAMP WITH CLIP</td> <td>2</td> <td>PZ</td> </tr> <tr> <td>RC1356A0</td> <td>STRAIGHT THREADED FEMALE END 8X1/4" BSP</td> <td>1</td> <td>PZ</td> </tr> <tr> <td>TB1818A0</td> <td>8X4.75 BLUE PE WATER INLET PIPE</td> <td>0.300</td> <td>M</td> </tr> <tr> <td>TB2820A0</td> <td>PIPE EPDM FOR WASHING SYSTEM</td> <td>1.240</td> <td>M</td> </tr> <tr> <td>VI1220A1</td> <td>4,2X12 TCB SELF-TAPPIN G SCREW</td> <td>2</td> <td>PZ</td> </tr> <tr> <td>VL1019A0</td> <td>VIBRATION PUMP</td> <td>1</td> <td>PZ</td> </tr> </tbody> </table>	Code	Description	Qty	UOM	0H7323A0	WASHING SYSTEM HOLDING PLATE	1	PZ	EL1020A1		1	PZ	EL1422A0	1 WAY SOLENOID VALVE + D8-D10 REDUCTION	1	PZ	EL1422A1	1 WAY SOLENOID VALVE + D8-D10 REDUCTION	1	PZ	EL1426A0	SOLENOID	1	PZ	EL1437A0		1	PZ	GN1526A0	INT. D.=6.9 TH=1.8 O-RING	1	PZ	RC1019A0	D=10 ELASTIC CLAMP	11	PZ	RC1130A0	130X2,6 CLAM	1	PZ	RC1242A0	D=10 CLOSED CAP	2	PZ	RC1310A0	140X4 CLAMP WITH CLIP	2	PZ	RC1356A0	STRAIGHT THREADED FEMALE END 8X1/4" BSP	1	PZ	TB1818A0	8X4.75 BLUE PE WATER INLET PIPE	0.300	M	TB2820A0	PIPE EPDM FOR WASHING SYSTEM	1.240	M	VI1220A1	4,2X12 TCB SELF-TAPPIN G SCREW	2	PZ	VL1019A0	VIBRATION PUMP	1	PZ
Code	Description	Qty	UOM																																																																						
0H7323A0	WASHING SYSTEM HOLDING PLATE	1	PZ																																																																						
EL1020A1		1	PZ																																																																						
EL1422A0	1 WAY SOLENOID VALVE + D8-D10 REDUCTION	1	PZ																																																																						
EL1422A1	1 WAY SOLENOID VALVE + D8-D10 REDUCTION	1	PZ																																																																						
EL1426A0	SOLENOID	1	PZ																																																																						
EL1437A0		1	PZ																																																																						
GN1526A0	INT. D.=6.9 TH=1.8 O-RING	1	PZ																																																																						
RC1019A0	D=10 ELASTIC CLAMP	11	PZ																																																																						
RC1130A0	130X2,6 CLAM	1	PZ																																																																						
RC1242A0	D=10 CLOSED CAP	2	PZ																																																																						
RC1310A0	140X4 CLAMP WITH CLIP	2	PZ																																																																						
RC1356A0	STRAIGHT THREADED FEMALE END 8X1/4" BSP	1	PZ																																																																						
TB1818A0	8X4.75 BLUE PE WATER INLET PIPE	0.300	M																																																																						
TB2820A0	PIPE EPDM FOR WASHING SYSTEM	1.240	M																																																																						
VI1220A1	4,2X12 TCB SELF-TAPPIN G SCREW	2	PZ																																																																						
VL1019A0	VIBRATION PUMP	1	PZ																																																																						

COMPONENT			SPARE PART																																																		
Code	Description	Image	Code	Description	Components list																																																
VL1019A	VIBRATION PUMP		KVL1104A		<table border="1"> <thead> <tr> <th>Code</th> <th>Description</th> <th>Qty</th> <th>UOM</th> </tr> </thead> <tbody> <tr> <td>VL1064A0</td> <td>WASHING SYSTEM OUTLETS DISTRIBUTOR</td> <td>1</td> <td>PZ</td> </tr> <tr> <td>VL1065A1</td> <td>1/4 MALE N.O. PRESSURE SWITCH</td> <td>1</td> <td>PZ</td> </tr> <tr> <td>VL1067A0</td> <td>WASHING SYSTEM INLETS DISTRIBUTOR</td> <td>1</td> <td>PZ</td> </tr> <tr> <td>VL1080A0</td> <td>DETERGENT FILTER</td> <td>1</td> <td>PZ</td> </tr> <tr> <td>VL1081A0</td> <td>D6 BARBED NO RETURN VALVE</td> <td>2</td> <td>PZ</td> </tr> <tr> <td>VL1083A0</td> <td>D=10 CONNECTION - D=6 PIPE FITTING</td> <td>1</td> <td>PZ</td> </tr> <tr> <td>VL1102A0</td> <td></td> <td>1</td> <td>PZ</td> </tr> <tr> <td>VM2172A0</td> <td>PUMP LOCKING CLIP</td> <td>1</td> <td>PZ</td> </tr> </tbody> </table>	Code	Description	Qty	UOM	VL1064A0	WASHING SYSTEM OUTLETS DISTRIBUTOR	1	PZ	VL1065A1	1/4 MALE N.O. PRESSURE SWITCH	1	PZ	VL1067A0	WASHING SYSTEM INLETS DISTRIBUTOR	1	PZ	VL1080A0	DETERGENT FILTER	1	PZ	VL1081A0	D6 BARBED NO RETURN VALVE	2	PZ	VL1083A0	D=10 CONNECTION - D=6 PIPE FITTING	1	PZ	VL1102A0		1	PZ	VM2172A0	PUMP LOCKING CLIP	1	PZ												
Code	Description	Qty	UOM																																																		
VL1064A0	WASHING SYSTEM OUTLETS DISTRIBUTOR	1	PZ																																																		
VL1065A1	1/4 MALE N.O. PRESSURE SWITCH	1	PZ																																																		
VL1067A0	WASHING SYSTEM INLETS DISTRIBUTOR	1	PZ																																																		
VL1080A0	DETERGENT FILTER	1	PZ																																																		
VL1081A0	D6 BARBED NO RETURN VALVE	2	PZ																																																		
VL1083A0	D=10 CONNECTION - D=6 PIPE FITTING	1	PZ																																																		
VL1102A0		1	PZ																																																		
VM2172A0	PUMP LOCKING CLIP	1	PZ																																																		
			KVL1103A	PLUS EU DOUBLE ROTOR WASHING SYSTEM KIT	<table border="1"> <thead> <tr> <th>Code</th> <th>Description</th> <th>Qty</th> <th>UOM</th> </tr> </thead> <tbody> <tr> <td>0H7323A0</td> <td>WASHING SYSTEM HOLDING PLATE</td> <td>1</td> <td>PZ</td> </tr> <tr> <td>EL1252A1</td> <td>1 WAY WATER VALVE + J.G. CONNECTION</td> <td>1</td> <td>PZ</td> </tr> <tr> <td>EL1424A0</td> <td>D8 CONNECTION WATER SOLENOID VALVE</td> <td>2</td> <td>PZ</td> </tr> <tr> <td>EL1436A0</td> <td></td> <td>1</td> <td>PZ</td> </tr> <tr> <td>GN1526A0</td> <td>INT. D.=6.9 TH=1.8 O-RING</td> <td>1</td> <td>PZ</td> </tr> <tr> <td>RC1019A0</td> <td>D=10 ELASTIC CLAMP</td> <td>12</td> <td>PZ</td> </tr> <tr> <td>RC1130A0</td> <td>130X2,6 CLAM</td> <td>1</td> <td>PZ</td> </tr> <tr> <td>RC1242A0</td> <td>D=10 CLOSED CAP</td> <td>2</td> <td>PZ</td> </tr> <tr> <td>RC1310A0</td> <td>140X4 CLAMP WITH CLIP</td> <td>2</td> <td>PZ</td> </tr> <tr> <td>RC1356A0</td> <td>STRAIGHT THREADED FEMALE END 8X1/4" BSP</td> <td>1</td> <td>PZ</td> </tr> <tr> <td>TB1818A0</td> <td>8X4.75 BLUE PE WATER INLET PIPE</td> <td>0.220</td> <td>M</td> </tr> </tbody> </table>	Code	Description	Qty	UOM	0H7323A0	WASHING SYSTEM HOLDING PLATE	1	PZ	EL1252A1	1 WAY WATER VALVE + J.G. CONNECTION	1	PZ	EL1424A0	D8 CONNECTION WATER SOLENOID VALVE	2	PZ	EL1436A0		1	PZ	GN1526A0	INT. D.=6.9 TH=1.8 O-RING	1	PZ	RC1019A0	D=10 ELASTIC CLAMP	12	PZ	RC1130A0	130X2,6 CLAM	1	PZ	RC1242A0	D=10 CLOSED CAP	2	PZ	RC1310A0	140X4 CLAMP WITH CLIP	2	PZ	RC1356A0	STRAIGHT THREADED FEMALE END 8X1/4" BSP	1	PZ	TB1818A0	8X4.75 BLUE PE WATER INLET PIPE	0.220	M
Code	Description	Qty	UOM																																																		
0H7323A0	WASHING SYSTEM HOLDING PLATE	1	PZ																																																		
EL1252A1	1 WAY WATER VALVE + J.G. CONNECTION	1	PZ																																																		
EL1424A0	D8 CONNECTION WATER SOLENOID VALVE	2	PZ																																																		
EL1436A0		1	PZ																																																		
GN1526A0	INT. D.=6.9 TH=1.8 O-RING	1	PZ																																																		
RC1019A0	D=10 ELASTIC CLAMP	12	PZ																																																		
RC1130A0	130X2,6 CLAM	1	PZ																																																		
RC1242A0	D=10 CLOSED CAP	2	PZ																																																		
RC1310A0	140X4 CLAMP WITH CLIP	2	PZ																																																		
RC1356A0	STRAIGHT THREADED FEMALE END 8X1/4" BSP	1	PZ																																																		
TB1818A0	8X4.75 BLUE PE WATER INLET PIPE	0.220	M																																																		

COMPONENT			SPARE PART																																																		
Code	Description	Image	Code	Description	Components list																																																
VL1019A	VIBRATION PUMP		KVL1103A	PLUS EU DOUBLE ROTOR WASHING SYSTEM KIT	<table border="1"> <thead> <tr> <th>Code</th> <th>Description</th> <th>Qty</th> <th>UOM</th> </tr> </thead> <tbody> <tr> <td>TB2820A0</td> <td>PIPE EPDM FOR WASHING SYSTEM</td> <td>2.040</td> <td>M</td> </tr> <tr> <td>VI1220A1</td> <td>4,2X12 TCB SELF-TAPPING SCREW</td> <td>2</td> <td>PZ</td> </tr> <tr> <td>VL1019A0</td> <td>VIBRATION PUMP</td> <td>1</td> <td>PZ</td> </tr> <tr> <td>VL1065A1</td> <td>1/4 MALE N.O. PRESSURE SWITCH</td> <td>1</td> <td>PZ</td> </tr> <tr> <td>VL1067A0</td> <td>WASHING SYSTEM INLETS DISTRIBUTOR</td> <td>1</td> <td>PZ</td> </tr> <tr> <td>VL1080A0</td> <td>DETERGENT FILTER</td> <td>1</td> <td>PZ</td> </tr> <tr> <td>VL1081A0</td> <td>D6 BARBED NO RETURN VALVE</td> <td>2</td> <td>PZ</td> </tr> <tr> <td>VL1083A0</td> <td>D=10 CONNECTION - D=6 PIPE FITTING</td> <td>1</td> <td>PZ</td> </tr> <tr> <td>VL1092A0</td> <td>WASHING SYSTEM OUTLET DOUBLE DISTRIBUTOR</td> <td>1</td> <td>PZ</td> </tr> <tr> <td>VL1102A0</td> <td></td> <td>1</td> <td>PZ</td> </tr> <tr> <td>VM2172A0</td> <td>PUMP LOCKING CLIP</td> <td>1</td> <td>PZ</td> </tr> </tbody> </table>	Code	Description	Qty	UOM	TB2820A0	PIPE EPDM FOR WASHING SYSTEM	2.040	M	VI1220A1	4,2X12 TCB SELF-TAPPING SCREW	2	PZ	VL1019A0	VIBRATION PUMP	1	PZ	VL1065A1	1/4 MALE N.O. PRESSURE SWITCH	1	PZ	VL1067A0	WASHING SYSTEM INLETS DISTRIBUTOR	1	PZ	VL1080A0	DETERGENT FILTER	1	PZ	VL1081A0	D6 BARBED NO RETURN VALVE	2	PZ	VL1083A0	D=10 CONNECTION - D=6 PIPE FITTING	1	PZ	VL1092A0	WASHING SYSTEM OUTLET DOUBLE DISTRIBUTOR	1	PZ	VL1102A0		1	PZ	VM2172A0	PUMP LOCKING CLIP	1	PZ
			Code	Description	Qty	UOM																																															
TB2820A0	PIPE EPDM FOR WASHING SYSTEM	2.040	M																																																		
VI1220A1	4,2X12 TCB SELF-TAPPING SCREW	2	PZ																																																		
VL1019A0	VIBRATION PUMP	1	PZ																																																		
VL1065A1	1/4 MALE N.O. PRESSURE SWITCH	1	PZ																																																		
VL1067A0	WASHING SYSTEM INLETS DISTRIBUTOR	1	PZ																																																		
VL1080A0	DETERGENT FILTER	1	PZ																																																		
VL1081A0	D6 BARBED NO RETURN VALVE	2	PZ																																																		
VL1083A0	D=10 CONNECTION - D=6 PIPE FITTING	1	PZ																																																		
VL1092A0	WASHING SYSTEM OUTLET DOUBLE DISTRIBUTOR	1	PZ																																																		
VL1102A0		1	PZ																																																		
VM2172A0	PUMP LOCKING CLIP	1	PZ																																																		
KVL1101A	PLUS EU WASHING SYSTEM KIT	<table border="1"> <thead> <tr> <th>Code</th> <th>Description</th> <th>Qty</th> <th>UOM</th> </tr> </thead> <tbody> <tr> <td>0H7323A0</td> <td>WASHING SYSTEM HOLDING PLATE</td> <td>1</td> <td>PZ</td> </tr> <tr> <td>EL1252A1</td> <td>1 WAY WATER VALVE + J.G. CONNECTION</td> <td>1</td> <td>PZ</td> </tr> <tr> <td>EL1424A0</td> <td>D8 CONNECTION WATER SOLENOID VALVE</td> <td>1</td> <td>PZ</td> </tr> <tr> <td>EL1436A0</td> <td></td> <td>1</td> <td>PZ</td> </tr> <tr> <td>GN1526A0</td> <td>INT. D.=6.9 TH=1.8 O-RING</td> <td>1</td> <td>PZ</td> </tr> <tr> <td>RC1019A0</td> <td>D=10 ELASTIC CLAMP</td> <td>11</td> <td>PZ</td> </tr> <tr> <td>RC1130A0</td> <td>130X2,6 CLAM</td> <td>1</td> <td>PZ</td> </tr> <tr> <td>RC1242A0</td> <td>D=10 CLOSED CAP</td> <td>2</td> <td>PZ</td> </tr> </tbody> </table>	Code	Description	Qty	UOM	0H7323A0	WASHING SYSTEM HOLDING PLATE	1	PZ	EL1252A1	1 WAY WATER VALVE + J.G. CONNECTION	1	PZ	EL1424A0	D8 CONNECTION WATER SOLENOID VALVE	1	PZ	EL1436A0		1	PZ	GN1526A0	INT. D.=6.9 TH=1.8 O-RING	1	PZ	RC1019A0	D=10 ELASTIC CLAMP	11	PZ	RC1130A0	130X2,6 CLAM	1	PZ	RC1242A0	D=10 CLOSED CAP	2	PZ															
Code	Description	Qty	UOM																																																		
0H7323A0	WASHING SYSTEM HOLDING PLATE	1	PZ																																																		
EL1252A1	1 WAY WATER VALVE + J.G. CONNECTION	1	PZ																																																		
EL1424A0	D8 CONNECTION WATER SOLENOID VALVE	1	PZ																																																		
EL1436A0		1	PZ																																																		
GN1526A0	INT. D.=6.9 TH=1.8 O-RING	1	PZ																																																		
RC1019A0	D=10 ELASTIC CLAMP	11	PZ																																																		
RC1130A0	130X2,6 CLAM	1	PZ																																																		
RC1242A0	D=10 CLOSED CAP	2	PZ																																																		



COMPONENT			SPARE PART																																																																																													
Code	Description	Image	Code	Description	Components list																																																																																											
VL1019A	VIBRATION PUMP		KVL1101A	PLUS EU WASHING SYSTEM KIT	<table border="1"> <thead> <tr> <th>Code</th> <th>Description</th> <th>Qty</th> <th>UOM</th> </tr> </thead> <tbody> <tr> <td>RC1310A0</td> <td>140X4 CLAMP WITH CLIP</td> <td>2</td> <td>PZ</td> </tr> <tr> <td>RC1356A0</td> <td>STRAIGHT THREADED FEMALE END 8X1/4" BSP</td> <td>1</td> <td>PZ</td> </tr> <tr> <td>RC1408A0</td> <td>DOUBLE WIRE SPRING CLAMP D10.8 ZN</td> <td>6</td> <td>PZ</td> </tr> <tr> <td>TB1818A0</td> <td>8X4.75 BLUE PE WATER INLET PIPE</td> <td>0.220</td> <td>M</td> </tr> <tr> <td>TB2820A0</td> <td>PIPE EPDM FOR WASHING SYSTEM</td> <td>1.240</td> <td>M</td> </tr> <tr> <td>VI1220A1</td> <td>4,2X12 TCB SELF-TAPPING SCREW</td> <td>2</td> <td>PZ</td> </tr> <tr> <td>VL1019A0</td> <td>VIBRATION PUMP</td> <td>1</td> <td>PZ</td> </tr> <tr> <td>VL1064A0</td> <td>WASHING SYSTEM OUTLETS DISTRIBUTOR</td> <td>1</td> <td>PZ</td> </tr> <tr> <td>VL1065A1</td> <td>1/4 MALE N.O. PRESSURE SWITCH</td> <td>1</td> <td>PZ</td> </tr> <tr> <td>VL1067A0</td> <td>WASHING SYSTEM INLETS DISTRIBUTOR</td> <td>1</td> <td>PZ</td> </tr> <tr> <td>VL1080A0</td> <td>DETERGENT FILTER</td> <td>1</td> <td>PZ</td> </tr> <tr> <td>VL1081A0</td> <td>D6 BARBED NO RETURN VALVE</td> <td>2</td> <td>PZ</td> </tr> <tr> <td>VL1083A0</td> <td>D=10 CONNECTION - D=6 PIPE FITTING</td> <td>1</td> <td>PZ</td> </tr> <tr> <td>VL1102A0</td> <td></td> <td>1</td> <td>PZ</td> </tr> <tr> <td>VM2172A0</td> <td>PUMP LOCKING CLIP</td> <td>1</td> <td>PZ</td> </tr> </tbody> </table>	Code	Description	Qty	UOM	RC1310A0	140X4 CLAMP WITH CLIP	2	PZ	RC1356A0	STRAIGHT THREADED FEMALE END 8X1/4" BSP	1	PZ	RC1408A0	DOUBLE WIRE SPRING CLAMP D10.8 ZN	6	PZ	TB1818A0	8X4.75 BLUE PE WATER INLET PIPE	0.220	M	TB2820A0	PIPE EPDM FOR WASHING SYSTEM	1.240	M	VI1220A1	4,2X12 TCB SELF-TAPPING SCREW	2	PZ	VL1019A0	VIBRATION PUMP	1	PZ	VL1064A0	WASHING SYSTEM OUTLETS DISTRIBUTOR	1	PZ	VL1065A1	1/4 MALE N.O. PRESSURE SWITCH	1	PZ	VL1067A0	WASHING SYSTEM INLETS DISTRIBUTOR	1	PZ	VL1080A0	DETERGENT FILTER	1	PZ	VL1081A0	D6 BARBED NO RETURN VALVE	2	PZ	VL1083A0	D=10 CONNECTION - D=6 PIPE FITTING	1	PZ	VL1102A0		1	PZ	VM2172A0	PUMP LOCKING CLIP	1	PZ	KVL1094A	0311 EU COMPLETE WATER SYSTEM KIT	<table border="1"> <thead> <tr> <th>Code</th> <th>Description</th> <th>Qty</th> <th>UOM</th> </tr> </thead> <tbody> <tr> <td>0H7494A0</td> <td></td> <td>1</td> <td>PZ</td> </tr> <tr> <td>EL1436A0</td> <td></td> <td>1</td> <td>PZ</td> </tr> <tr> <td>GN1526A0</td> <td>INT. D.=6.9 TH=1.8 O-RING</td> <td>1</td> <td>PZ</td> </tr> <tr> <td>RC1006A0</td> <td>D8 PET PIPE GUIDE BEND</td> <td>2</td> <td>PZ</td> </tr> <tr> <td>RC1019A0</td> <td>D=10 ELASTIC CLAMP</td> <td>15</td> <td>PZ</td> </tr> </tbody> </table>	Code	Description	Qty	UOM	0H7494A0		1	PZ	EL1436A0		1	PZ	GN1526A0	INT. D.=6.9 TH=1.8 O-RING	1	PZ	RC1006A0	D8 PET PIPE GUIDE BEND	2	PZ	RC1019A0	D=10 ELASTIC CLAMP	15	PZ
			Code	Description	Qty	UOM																																																																																										
RC1310A0	140X4 CLAMP WITH CLIP	2	PZ																																																																																													
RC1356A0	STRAIGHT THREADED FEMALE END 8X1/4" BSP	1	PZ																																																																																													
RC1408A0	DOUBLE WIRE SPRING CLAMP D10.8 ZN	6	PZ																																																																																													
TB1818A0	8X4.75 BLUE PE WATER INLET PIPE	0.220	M																																																																																													
TB2820A0	PIPE EPDM FOR WASHING SYSTEM	1.240	M																																																																																													
VI1220A1	4,2X12 TCB SELF-TAPPING SCREW	2	PZ																																																																																													
VL1019A0	VIBRATION PUMP	1	PZ																																																																																													
VL1064A0	WASHING SYSTEM OUTLETS DISTRIBUTOR	1	PZ																																																																																													
VL1065A1	1/4 MALE N.O. PRESSURE SWITCH	1	PZ																																																																																													
VL1067A0	WASHING SYSTEM INLETS DISTRIBUTOR	1	PZ																																																																																													
VL1080A0	DETERGENT FILTER	1	PZ																																																																																													
VL1081A0	D6 BARBED NO RETURN VALVE	2	PZ																																																																																													
VL1083A0	D=10 CONNECTION - D=6 PIPE FITTING	1	PZ																																																																																													
VL1102A0		1	PZ																																																																																													
VM2172A0	PUMP LOCKING CLIP	1	PZ																																																																																													
Code	Description	Qty	UOM																																																																																													
0H7494A0		1	PZ																																																																																													
EL1436A0		1	PZ																																																																																													
GN1526A0	INT. D.=6.9 TH=1.8 O-RING	1	PZ																																																																																													
RC1006A0	D8 PET PIPE GUIDE BEND	2	PZ																																																																																													
RC1019A0	D=10 ELASTIC CLAMP	15	PZ																																																																																													

COMPONENT			SPARE PART																																																						
Code	Description	Image	Code	Description	Components list																																																				
VL1019A	VIBRATION PUMP		KVL1094A	0311 EU COMPLETE WATER SYSTEM KIT	<table border="1"> <thead> <tr> <th>Code</th> <th>Description</th> <th>Qty</th> <th>UOM</th> </tr> </thead> <tbody> <tr> <td>RC1242A0</td> <td>D=10 CLOSED CAP</td> <td>2</td> <td>PZ</td> </tr> <tr> <td>RC1408A0</td> <td>DOUBLE WIRE SPRING CLAMP D10.8 ZN</td> <td>4</td> <td>PZ</td> </tr> <tr> <td>TB1818A0</td> <td>8X4.75 BLUE PE WATER INLET PIPE</td> <td>0.320</td> <td>M</td> </tr> <tr> <td>TB2820A0</td> <td>PIPE EPDM FOR WASHING SYSTEM</td> <td>1.030</td> <td>M</td> </tr> <tr> <td>VI1220A1</td> <td>4,2X12 TCB SELF-TAPPIN G SCREW</td> <td>1</td> <td>PZ</td> </tr> <tr> <td>VL1019A0</td> <td>VIBRATION PUMP</td> <td>1</td> <td>PZ</td> </tr> <tr> <td>VL1053B0</td> <td></td> <td>1</td> <td>PZ</td> </tr> <tr> <td>VL1054B0</td> <td></td> <td>1</td> <td>PZ</td> </tr> <tr> <td>VL1080A0</td> <td>DETERGENT FILTER</td> <td>1</td> <td>PZ</td> </tr> <tr> <td>VL1081A0</td> <td>D6 BARBED NO RETURN VALVE</td> <td>1</td> <td>PZ</td> </tr> <tr> <td>VL1102A0</td> <td></td> <td>1</td> <td>PZ</td> </tr> <tr> <td>VM2172A0</td> <td>PUMP LOCKING CLIP</td> <td>1</td> <td>PZ</td> </tr> </tbody> </table>	Code	Description	Qty	UOM	RC1242A0	D=10 CLOSED CAP	2	PZ	RC1408A0	DOUBLE WIRE SPRING CLAMP D10.8 ZN	4	PZ	TB1818A0	8X4.75 BLUE PE WATER INLET PIPE	0.320	M	TB2820A0	PIPE EPDM FOR WASHING SYSTEM	1.030	M	VI1220A1	4,2X12 TCB SELF-TAPPIN G SCREW	1	PZ	VL1019A0	VIBRATION PUMP	1	PZ	VL1053B0		1	PZ	VL1054B0		1	PZ	VL1080A0	DETERGENT FILTER	1	PZ	VL1081A0	D6 BARBED NO RETURN VALVE	1	PZ	VL1102A0		1	PZ	VM2172A0	PUMP LOCKING CLIP	1	PZ
			Code	Description	Qty	UOM																																																			
RC1242A0	D=10 CLOSED CAP	2	PZ																																																						
RC1408A0	DOUBLE WIRE SPRING CLAMP D10.8 ZN	4	PZ																																																						
TB1818A0	8X4.75 BLUE PE WATER INLET PIPE	0.320	M																																																						
TB2820A0	PIPE EPDM FOR WASHING SYSTEM	1.030	M																																																						
VI1220A1	4,2X12 TCB SELF-TAPPIN G SCREW	1	PZ																																																						
VL1019A0	VIBRATION PUMP	1	PZ																																																						
VL1053B0		1	PZ																																																						
VL1054B0		1	PZ																																																						
VL1080A0	DETERGENT FILTER	1	PZ																																																						
VL1081A0	D6 BARBED NO RETURN VALVE	1	PZ																																																						
VL1102A0		1	PZ																																																						
VM2172A0	PUMP LOCKING CLIP	1	PZ																																																						
KVL1092A	MM PLUS PUMP CIRCUIT DOUBLE ROTOR KIT	<table border="1"> <thead> <tr> <th>Code</th> <th>Description</th> <th>Qty</th> <th>UOM</th> </tr> </thead> <tbody> <tr> <td>GN1526A0</td> <td>INT. D.=6.9 TH=1.8 O-RIN</td> <td>1</td> <td>PZ</td> </tr> <tr> <td>RC1019A0</td> <td>D=10 ELASTIC CLAMP</td> <td>4</td> <td>PZ</td> </tr> <tr> <td>RC1130A0</td> <td>130X2,6 CLAM</td> <td>1</td> <td>PZ</td> </tr> <tr> <td>RC1242A0</td> <td>D=10 CLOSED CAP</td> <td>2</td> <td>PZ</td> </tr> <tr> <td>RC1408A0</td> <td>DOUBLE WIRE SPRING CLAMP D10.8 ZN</td> <td>4</td> <td>PZ</td> </tr> <tr> <td>TB2820A0</td> <td>PIPE EPDM FOR WASHING SYSTEM</td> <td>0.120</td> <td>M</td> </tr> <tr> <td>VI1220A1</td> <td>4,2X12 TCB SELF-TAPPIN G SCREW</td> <td>2</td> <td>PZ</td> </tr> <tr> <td>VL1019A0</td> <td>VIBRATION PUMP</td> <td>1</td> <td>PZ</td> </tr> <tr> <td>VL1067A0</td> <td>WASHING SYSTEM INLETS DISTRIBUTOR</td> <td>1</td> <td>PZ</td> </tr> <tr> <td>VL1081A0</td> <td>D6 BARBED NO RETURN VALVE</td> <td>1</td> <td>PZ</td> </tr> </tbody> </table>	Code	Description	Qty	UOM	GN1526A0	INT. D.=6.9 TH=1.8 O-RIN	1	PZ	RC1019A0	D=10 ELASTIC CLAMP	4	PZ	RC1130A0	130X2,6 CLAM	1	PZ	RC1242A0	D=10 CLOSED CAP	2	PZ	RC1408A0	DOUBLE WIRE SPRING CLAMP D10.8 ZN	4	PZ	TB2820A0	PIPE EPDM FOR WASHING SYSTEM	0.120	M	VI1220A1	4,2X12 TCB SELF-TAPPIN G SCREW	2	PZ	VL1019A0	VIBRATION PUMP	1	PZ	VL1067A0	WASHING SYSTEM INLETS DISTRIBUTOR	1	PZ	VL1081A0	D6 BARBED NO RETURN VALVE	1	PZ											
Code	Description	Qty	UOM																																																						
GN1526A0	INT. D.=6.9 TH=1.8 O-RIN	1	PZ																																																						
RC1019A0	D=10 ELASTIC CLAMP	4	PZ																																																						
RC1130A0	130X2,6 CLAM	1	PZ																																																						
RC1242A0	D=10 CLOSED CAP	2	PZ																																																						
RC1408A0	DOUBLE WIRE SPRING CLAMP D10.8 ZN	4	PZ																																																						
TB2820A0	PIPE EPDM FOR WASHING SYSTEM	0.120	M																																																						
VI1220A1	4,2X12 TCB SELF-TAPPIN G SCREW	2	PZ																																																						
VL1019A0	VIBRATION PUMP	1	PZ																																																						
VL1067A0	WASHING SYSTEM INLETS DISTRIBUTOR	1	PZ																																																						
VL1081A0	D6 BARBED NO RETURN VALVE	1	PZ																																																						









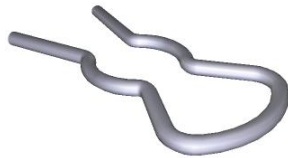

COMPONENT			SPARE PART																																															
Code	Description	Image	Code	Description	Components list																																													
VL1019A	VIBRATION PUMP		KVL1092A	MM PLUS PUMP CIRCUIT DOUBLE ROTOR KIT	<table border="1"> <thead> <tr> <th>Code</th> <th>Description</th> <th>Qty</th> <th>UOM</th> </tr> </thead> <tbody> <tr> <td>VL1092A0</td> <td>WASHING SYSTEM OUTLET DOUBLE DISTRIBUTOR</td> <td>1</td> <td>PZ</td> </tr> <tr> <td>VM2172A0</td> <td>PUMP LOCKING CLIP</td> <td>1</td> <td>PZ</td> </tr> </tbody> </table>	Code	Description	Qty	UOM	VL1092A0	WASHING SYSTEM OUTLET DOUBLE DISTRIBUTOR	1	PZ	VM2172A0	PUMP LOCKING CLIP	1	PZ																																	
			Code	Description	Qty	UOM																																												
			VL1092A0	WASHING SYSTEM OUTLET DOUBLE DISTRIBUTOR	1	PZ																																												
VM2172A0	PUMP LOCKING CLIP	1	PZ																																															
KVL1073A	MIND.MAPS PLUS OVENS PUMP CIRCUIT KIT	<table border="1"> <thead> <tr> <th>Code</th> <th>Description</th> <th>Qty</th> <th>UOM</th> </tr> </thead> <tbody> <tr> <td>GN1526A0</td> <td>INT. D.=6.9 TH=1.8 O-RIN</td> <td>1</td> <td>PZ</td> </tr> <tr> <td>RC1019A0</td> <td>D=10 ELASTIC CLAMP</td> <td>4</td> <td>PZ</td> </tr> <tr> <td>RC1130A0</td> <td>130X2,6 CLAM</td> <td>1</td> <td>PZ</td> </tr> <tr> <td>RC1242A0</td> <td>D=10 CLOSED CAP</td> <td>2</td> <td>PZ</td> </tr> <tr> <td>RC1408A0</td> <td>DOUBLE WIRE SPRING CLAMP D10.8 ZN</td> <td>2</td> <td>PZ</td> </tr> <tr> <td>TB2820A0</td> <td>PIPE EPDM FOR WASHING SYSTEM</td> <td>0.120</td> <td>M</td> </tr> <tr> <td>VL1019A0</td> <td>VIBRATION PUMP</td> <td>1</td> <td>PZ</td> </tr> <tr> <td>VL1064A0</td> <td>WASHING SYSTEM OUTLETS DISTRIBUTOR</td> <td>1</td> <td>PZ</td> </tr> <tr> <td>VL1067A0</td> <td>WASHING SYSTEM INLETS DISTRIBUTOR</td> <td>1</td> <td>PZ</td> </tr> <tr> <td>VL1081A0</td> <td>D6 BARBED NO RETURN VALVE</td> <td>1</td> <td>PZ</td> </tr> <tr> <td>VM2172A0</td> <td>PUMP LOCKING CLIP</td> <td>1</td> <td>PZ</td> </tr> </tbody> </table>	Code	Description	Qty	UOM	GN1526A0	INT. D.=6.9 TH=1.8 O-RIN	1	PZ	RC1019A0	D=10 ELASTIC CLAMP	4	PZ	RC1130A0	130X2,6 CLAM	1	PZ	RC1242A0	D=10 CLOSED CAP	2	PZ	RC1408A0	DOUBLE WIRE SPRING CLAMP D10.8 ZN	2	PZ	TB2820A0	PIPE EPDM FOR WASHING SYSTEM	0.120	M	VL1019A0	VIBRATION PUMP	1	PZ	VL1064A0	WASHING SYSTEM OUTLETS DISTRIBUTOR	1	PZ	VL1067A0	WASHING SYSTEM INLETS DISTRIBUTOR	1	PZ	VL1081A0	D6 BARBED NO RETURN VALVE	1	PZ	VM2172A0	PUMP LOCKING CLIP	1	PZ
Code	Description	Qty	UOM																																															
GN1526A0	INT. D.=6.9 TH=1.8 O-RIN	1	PZ																																															
RC1019A0	D=10 ELASTIC CLAMP	4	PZ																																															
RC1130A0	130X2,6 CLAM	1	PZ																																															
RC1242A0	D=10 CLOSED CAP	2	PZ																																															
RC1408A0	DOUBLE WIRE SPRING CLAMP D10.8 ZN	2	PZ																																															
TB2820A0	PIPE EPDM FOR WASHING SYSTEM	0.120	M																																															
VL1019A0	VIBRATION PUMP	1	PZ																																															
VL1064A0	WASHING SYSTEM OUTLETS DISTRIBUTOR	1	PZ																																															
VL1067A0	WASHING SYSTEM INLETS DISTRIBUTOR	1	PZ																																															
VL1081A0	D6 BARBED NO RETURN VALVE	1	PZ																																															
VM2172A0	PUMP LOCKING CLIP	1	PZ																																															
KVL1072A	MIND.MAPS ONE OVENS PUMP CIRCUIT KIT	<table border="1"> <thead> <tr> <th>Code</th> <th>Description</th> <th>Qty</th> <th>UOM</th> </tr> </thead> <tbody> <tr> <td>GN1526A0</td> <td>INT. D.=6.9 TH=1.8 O-RIN</td> <td>1</td> <td>PZ</td> </tr> <tr> <td>RC1019A0</td> <td>D=10 ELASTIC CLAMP</td> <td>3</td> <td>PZ</td> </tr> <tr> <td>RC1242A0</td> <td>D=10 CLOSED CAP</td> <td>2</td> <td>PZ</td> </tr> <tr> <td>RC1408A0</td> <td>DOUBLE WIRE SPRING CLAMP D10.8 ZN</td> <td>2</td> <td>PZ</td> </tr> <tr> <td>TB2820A0</td> <td>PIPE EPDM FOR WASHING SYSTEM</td> <td>0.120</td> <td>M</td> </tr> <tr> <td>VI1220A1</td> <td>4,2X12 TCB SELF-TAPPIN G SCREW</td> <td>1</td> <td>PZ</td> </tr> </tbody> </table>	Code	Description	Qty	UOM	GN1526A0	INT. D.=6.9 TH=1.8 O-RIN	1	PZ	RC1019A0	D=10 ELASTIC CLAMP	3	PZ	RC1242A0	D=10 CLOSED CAP	2	PZ	RC1408A0	DOUBLE WIRE SPRING CLAMP D10.8 ZN	2	PZ	TB2820A0	PIPE EPDM FOR WASHING SYSTEM	0.120	M	VI1220A1	4,2X12 TCB SELF-TAPPIN G SCREW	1	PZ																				
Code	Description	Qty	UOM																																															
GN1526A0	INT. D.=6.9 TH=1.8 O-RIN	1	PZ																																															
RC1019A0	D=10 ELASTIC CLAMP	3	PZ																																															
RC1242A0	D=10 CLOSED CAP	2	PZ																																															
RC1408A0	DOUBLE WIRE SPRING CLAMP D10.8 ZN	2	PZ																																															
TB2820A0	PIPE EPDM FOR WASHING SYSTEM	0.120	M																																															
VI1220A1	4,2X12 TCB SELF-TAPPIN G SCREW	1	PZ																																															







COMPONENT			SPARE PART																																																															
Code	Description	Image	Code	Description	Components list																																																													
VL1019A	VIBRATION PUMP		KVL1072A	MIND.MAPS ONE OVENS PUMP CIRCUIT KIT	<table border="1"> <thead> <tr> <th>Code</th> <th>Description</th> <th>Qty</th> <th>UOM</th> </tr> </thead> <tbody> <tr> <td>VL1019A0</td> <td>VIBRATION PUMP</td> <td>1</td> <td>PZ</td> </tr> <tr> <td>VL1053B0</td> <td></td> <td>1</td> <td>PZ</td> </tr> <tr> <td>VL1054B0</td> <td></td> <td>1</td> <td>PZ</td> </tr> <tr> <td>VL1081A0</td> <td>D6 BARBED NO RETURN VALVE</td> <td>2</td> <td>PZ</td> </tr> <tr> <td>VM2172A0</td> <td>PUMP LOCKING CLIP</td> <td>1</td> <td>PZ</td> </tr> </tbody> </table>	Code	Description	Qty	UOM	VL1019A0	VIBRATION PUMP	1	PZ	VL1053B0		1	PZ	VL1054B0		1	PZ	VL1081A0	D6 BARBED NO RETURN VALVE	2	PZ	VM2172A0	PUMP LOCKING CLIP	1	PZ																																					
			Code	Description	Qty	UOM																																																												
VL1019A0	VIBRATION PUMP	1	PZ																																																															
VL1053B0		1	PZ																																																															
VL1054B0		1	PZ																																																															
VL1081A0	D6 BARBED NO RETURN VALVE	2	PZ																																																															
VM2172A0	PUMP LOCKING CLIP	1	PZ																																																															
KVL0001A	LM TOP WASHING SYSTEM CIRCUIT KI	<table border="1"> <thead> <tr> <th>Code</th> <th>Description</th> <th>Qty</th> <th>UOM</th> </tr> </thead> <tbody> <tr> <td>0H1226A0</td> <td>LINEMISSTOP WASHING SYTEM CIRCUIT COVE</td> <td>1</td> <td>PZ</td> </tr> <tr> <td>0H1226B0</td> <td>LINEMISSTOP WASHING SYTEM CIRCUIT COVE</td> <td>1</td> <td>PZ</td> </tr> <tr> <td>EL1180A0</td> <td>Ø8-Ø8 FEMALE NON-RETURN CONNECTION</td> <td>1</td> <td>PZ</td> </tr> <tr> <td>GN1312A0</td> <td>RUBBER CABLE-PASSI NG DE=26 DI=15 SP=10</td> <td>1</td> <td>PZ</td> </tr> <tr> <td>GN1526A0</td> <td>INT. D.=6.9 TH=1.8 O-RIN</td> <td>1</td> <td>PZ</td> </tr> <tr> <td>RC1008A0</td> <td>D9 ELASTIC CLIP</td> <td>3</td> <td>PZ</td> </tr> <tr> <td>RC1019A0</td> <td>D=10 ELASTIC CLAMP</td> <td>3</td> <td>PZ</td> </tr> <tr> <td>RC1242A0</td> <td>D=10 CLOSED CAP</td> <td>2</td> <td>PZ</td> </tr> <tr> <td>RC1381A0</td> <td>BIFILAR PIPE CLIP D10.7</td> <td>3</td> <td>PZ</td> </tr> <tr> <td>RC1408A0</td> <td>DOUBLE WIRE SPRING CLAMP D10.8 ZN</td> <td>2</td> <td>PZ</td> </tr> <tr> <td>TB2343A0</td> <td>9X6 PVC TRANSPAREN T PIPE</td> <td>2.630</td> <td>M</td> </tr> <tr> <td>TB2820A0</td> <td>PIPE EPDM FOR WASHING SYSTEM</td> <td>0.990</td> <td>M</td> </tr> <tr> <td>VI1220A1</td> <td>4,2X12 TCB SELF-TAPPIN G SCREW</td> <td>1</td> <td>PZ</td> </tr> <tr> <td>VL1019A0</td> <td>VIBRATION PUMP</td> <td>1</td> <td>PZ</td> </tr> <tr> <td>VL1041C0</td> <td>DETERGENT CAP WITH Ø12 HOLE</td> <td>1</td> <td>PZ</td> </tr> </tbody> </table>	Code	Description	Qty	UOM	0H1226A0	LINEMISSTOP WASHING SYTEM CIRCUIT COVE	1	PZ	0H1226B0	LINEMISSTOP WASHING SYTEM CIRCUIT COVE	1	PZ	EL1180A0	Ø8-Ø8 FEMALE NON-RETURN CONNECTION	1	PZ	GN1312A0	RUBBER CABLE-PASSI NG DE=26 DI=15 SP=10	1	PZ	GN1526A0	INT. D.=6.9 TH=1.8 O-RIN	1	PZ	RC1008A0	D9 ELASTIC CLIP	3	PZ	RC1019A0	D=10 ELASTIC CLAMP	3	PZ	RC1242A0	D=10 CLOSED CAP	2	PZ	RC1381A0	BIFILAR PIPE CLIP D10.7	3	PZ	RC1408A0	DOUBLE WIRE SPRING CLAMP D10.8 ZN	2	PZ	TB2343A0	9X6 PVC TRANSPAREN T PIPE	2.630	M	TB2820A0	PIPE EPDM FOR WASHING SYSTEM	0.990	M	VI1220A1	4,2X12 TCB SELF-TAPPIN G SCREW	1	PZ	VL1019A0	VIBRATION PUMP	1	PZ	VL1041C0	DETERGENT CAP WITH Ø12 HOLE	1	PZ
Code	Description	Qty	UOM																																																															
0H1226A0	LINEMISSTOP WASHING SYTEM CIRCUIT COVE	1	PZ																																																															
0H1226B0	LINEMISSTOP WASHING SYTEM CIRCUIT COVE	1	PZ																																																															
EL1180A0	Ø8-Ø8 FEMALE NON-RETURN CONNECTION	1	PZ																																																															
GN1312A0	RUBBER CABLE-PASSI NG DE=26 DI=15 SP=10	1	PZ																																																															
GN1526A0	INT. D.=6.9 TH=1.8 O-RIN	1	PZ																																																															
RC1008A0	D9 ELASTIC CLIP	3	PZ																																																															
RC1019A0	D=10 ELASTIC CLAMP	3	PZ																																																															
RC1242A0	D=10 CLOSED CAP	2	PZ																																																															
RC1381A0	BIFILAR PIPE CLIP D10.7	3	PZ																																																															
RC1408A0	DOUBLE WIRE SPRING CLAMP D10.8 ZN	2	PZ																																																															
TB2343A0	9X6 PVC TRANSPAREN T PIPE	2.630	M																																																															
TB2820A0	PIPE EPDM FOR WASHING SYSTEM	0.990	M																																																															
VI1220A1	4,2X12 TCB SELF-TAPPIN G SCREW	1	PZ																																																															
VL1019A0	VIBRATION PUMP	1	PZ																																																															
VL1041C0	DETERGENT CAP WITH Ø12 HOLE	1	PZ																																																															

COMPONENT			SPARE PART																																																		
Code	Description	Image	Code	Description	Components list																																																
VL1019A	VIBRATION PUMP		KVL0001A	LM TOP WASHING SYSTEM CIRCUIT KI	<table border="1"> <thead> <tr> <th>Code</th> <th>Description</th> <th>Qty</th> <th>UOM</th> </tr> </thead> <tbody> <tr> <td>VL1047A1</td> <td>D6 PIPE HOLDER - D8 J.G. TERMINAL</td> <td>1</td> <td>PZ</td> </tr> <tr> <td>VL1053A1</td> <td></td> <td>1</td> <td>PZ</td> </tr> <tr> <td>VL1053B0</td> <td></td> <td>1</td> <td>PZ</td> </tr> <tr> <td>VL1054A1</td> <td></td> <td>1</td> <td>PZ</td> </tr> <tr> <td>VL1054B0</td> <td></td> <td>1</td> <td>PZ</td> </tr> <tr> <td>VL1061A0</td> <td>HOLD DOWN WEIGHT+NET FILTER+NON-RET. V.</td> <td>1</td> <td>PZ</td> </tr> <tr> <td>VL1081A0</td> <td>D6 BARBED NO RETURN VALVE</td> <td>1</td> <td>PZ</td> </tr> <tr> <td>VM1066A0</td> <td>SADDLE CLIP FOR CABLES PASSING</td> <td>3</td> <td>PZ</td> </tr> <tr> <td>VM1088A0</td> <td>NYLON CLICK CLAMP D7.9-D9.2</td> <td>1</td> <td>PZ</td> </tr> <tr> <td>VM1605A0</td> <td>CLIP TWIST LOCK DIAM. 10,2-12,7 MM</td> <td>1</td> <td>PZ</td> </tr> <tr> <td>VM2172A0</td> <td>PUMP LOCKING CLIP</td> <td>1</td> <td>PZ</td> </tr> </tbody> </table>	Code	Description	Qty	UOM	VL1047A1	D6 PIPE HOLDER - D8 J.G. TERMINAL	1	PZ	VL1053A1		1	PZ	VL1053B0		1	PZ	VL1054A1		1	PZ	VL1054B0		1	PZ	VL1061A0	HOLD DOWN WEIGHT+NET FILTER+NON-RET. V.	1	PZ	VL1081A0	D6 BARBED NO RETURN VALVE	1	PZ	VM1066A0	SADDLE CLIP FOR CABLES PASSING	3	PZ	VM1088A0	NYLON CLICK CLAMP D7.9-D9.2	1	PZ	VM1605A0	CLIP TWIST LOCK DIAM. 10,2-12,7 MM	1	PZ	VM2172A0	PUMP LOCKING CLIP	1	PZ
Code	Description	Qty	UOM																																																		
VL1047A1	D6 PIPE HOLDER - D8 J.G. TERMINAL	1	PZ																																																		
VL1053A1		1	PZ																																																		
VL1053B0		1	PZ																																																		
VL1054A1		1	PZ																																																		
VL1054B0		1	PZ																																																		
VL1061A0	HOLD DOWN WEIGHT+NET FILTER+NON-RET. V.	1	PZ																																																		
VL1081A0	D6 BARBED NO RETURN VALVE	1	PZ																																																		
VM1066A0	SADDLE CLIP FOR CABLES PASSING	3	PZ																																																		
VM1088A0	NYLON CLICK CLAMP D7.9-D9.2	1	PZ																																																		
VM1605A0	CLIP TWIST LOCK DIAM. 10,2-12,7 MM	1	PZ																																																		
VM2172A0	PUMP LOCKING CLIP	1	PZ																																																		
VM2172A	PUMP LOCKING CLI		VM2172A0	PUMP LOCKING CLI																																																	
RC1019A	D=10 ELASTIC CLAM		KRC1019A	Ø10 ZINC PLATED ELASTIC CLAMP 15PCS KIT	<table border="1"> <thead> <tr> <th>Code</th> <th>Description</th> <th>Qty</th> <th>UOM</th> </tr> </thead> <tbody> <tr> <td>RC1019A0</td> <td>D=10 ELASTIC CLAMP</td> <td>15</td> <td>PZ</td> </tr> </tbody> </table>	Code	Description	Qty	UOM	RC1019A0	D=10 ELASTIC CLAMP	15	PZ																																								
Code	Description	Qty	UOM																																																		
RC1019A0	D=10 ELASTIC CLAMP	15	PZ																																																		





COMPONENT			SPARE PART																		
Code	Description	Image	Code	Description	Components list																
VL1081A	D6 BARBED NO RETURN VALVE		KVL1102A	DETERGENT FILTER KIT	<table border="1"> <thead> <tr> <th>Code</th> <th>Description</th> <th>Qty</th> <th>UOM</th> </tr> </thead> <tbody> <tr> <td>RC1019A0</td> <td>D=10 ELASTIC CLAMP</td> <td>3</td> <td>PZ</td> </tr> <tr> <td>TB2820A0</td> <td>PIPE EPDM FOR WASHING SYSTEM</td> <td>0.110</td> <td>M</td> </tr> <tr> <td>VL1102A0</td> <td></td> <td>1</td> <td>PZ</td> </tr> </tbody> </table>	Code	Description	Qty	UOM	RC1019A0	D=10 ELASTIC CLAMP	3	PZ	TB2820A0	PIPE EPDM FOR WASHING SYSTEM	0.110	M	VL1102A0		1	PZ
			Code	Description	Qty	UOM															
RC1019A0	D=10 ELASTIC CLAMP	3	PZ																		
TB2820A0	PIPE EPDM FOR WASHING SYSTEM	0.110	M																		
VL1102A0		1	PZ																		
KVL1081A	D6 BARBED NO RETURN VALVE 2PCS KIT	<table border="1"> <thead> <tr> <th>Code</th> <th>Description</th> <th>Qty</th> <th>UOM</th> </tr> </thead> <tbody> <tr> <td>TB2820A0</td> <td>PIPE EPDM FOR WASHING SYSTEM</td> <td>0.240</td> <td>M</td> </tr> <tr> <td>VL1081A0</td> <td>D6 BARBED NO RETURN VALVE</td> <td>3</td> <td>PZ</td> </tr> </tbody> </table>	Code	Description	Qty	UOM	TB2820A0	PIPE EPDM FOR WASHING SYSTEM	0.240	M	VL1081A0	D6 BARBED NO RETURN VALVE	3	PZ							
Code	Description	Qty	UOM																		
TB2820A0	PIPE EPDM FOR WASHING SYSTEM	0.240	M																		
VL1081A0	D6 BARBED NO RETURN VALVE	3	PZ																		
VL1080A	DETERGENT FILTER		KVL1102A	DETERGENT FILTER KIT	<table border="1"> <thead> <tr> <th>Code</th> <th>Description</th> <th>Qty</th> <th>UOM</th> </tr> </thead> <tbody> <tr> <td>RC1019A0</td> <td>D=10 ELASTIC CLAMP</td> <td>3</td> <td>PZ</td> </tr> <tr> <td>TB2820A0</td> <td>PIPE EPDM FOR WASHING SYSTEM</td> <td>0.110</td> <td>M</td> </tr> <tr> <td>VL1102A0</td> <td></td> <td>1</td> <td>PZ</td> </tr> </tbody> </table>	Code	Description	Qty	UOM	RC1019A0	D=10 ELASTIC CLAMP	3	PZ	TB2820A0	PIPE EPDM FOR WASHING SYSTEM	0.110	M	VL1102A0		1	PZ
			Code	Description	Qty	UOM															
RC1019A0	D=10 ELASTIC CLAMP	3	PZ																		
TB2820A0	PIPE EPDM FOR WASHING SYSTEM	0.110	M																		
VL1102A0		1	PZ																		
KVL1080A	DETERGENT FILTER KIT	<table border="1"> <thead> <tr> <th>Code</th> <th>Description</th> <th>Qty</th> <th>UOM</th> </tr> </thead> <tbody> <tr> <td>RC1019A0</td> <td>D=10 ELASTIC CLAMP</td> <td>2</td> <td>PZ</td> </tr> <tr> <td>TB2820A0</td> <td>PIPE EPDM FOR WASHING SYSTEM</td> <td>0.080</td> <td>M</td> </tr> <tr> <td>VL1080A0</td> <td>DETERGENT FILTER</td> <td>1</td> <td>PZ</td> </tr> </tbody> </table>	Code	Description	Qty	UOM	RC1019A0	D=10 ELASTIC CLAMP	2	PZ	TB2820A0	PIPE EPDM FOR WASHING SYSTEM	0.080	M	VL1080A0	DETERGENT FILTER	1	PZ			
Code	Description	Qty	UOM																		
RC1019A0	D=10 ELASTIC CLAMP	2	PZ																		
TB2820A0	PIPE EPDM FOR WASHING SYSTEM	0.080	M																		
VL1080A0	DETERGENT FILTER	1	PZ																		
RC1242A	D=10 CLOSED CAP		RC1242A0	D=10 CLOSED CAP																	
RC1006A	D8 PET PIPE GUIDE BEND		KRC1006A	20 PCS. Ø8 PET PIPE GUIDE BEND KI	<table border="1"> <thead> <tr> <th>Code</th> <th>Description</th> <th>Qty</th> <th>UOM</th> </tr> </thead> <tbody> <tr> <td>RC1006A0</td> <td>D8 PET PIPE GUIDE BEND</td> <td>20</td> <td>PZ</td> </tr> </tbody> </table>	Code	Description	Qty	UOM	RC1006A0	D8 PET PIPE GUIDE BEND	20	PZ								
Code	Description	Qty	UOM																		
RC1006A0	D8 PET PIPE GUIDE BEND	20	PZ																		

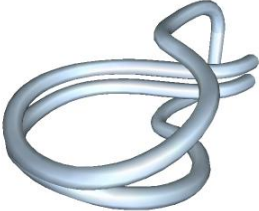

COMPONENT			SPARE PART																																						
Code	Description	Image	Code	Description	Components list																																				
VL1084A	T SHAPED BARBED FITTING 1/4		VL1084A0	T SHAPED BARBED FITTING 1/4																																					
VL1054B			KVL1054B	ONE WASHING SYST INLETS DISTRIBUTOR KIT	<table border="1"> <thead> <tr> <th>Code</th> <th>Description</th> <th>Qty</th> <th>UOM</th> </tr> </thead> <tbody> <tr> <td>VL1054B0</td> <td></td> <td>1</td> <td>PZ</td> </tr> </tbody> </table>	Code	Description	Qty	UOM	VL1054B0		1	PZ																												
Code	Description	Qty	UOM																																						
VL1054B0		1	PZ																																						
TB3009A			KTB1349A	8X4.75 BLUE PE WATER INLET PIPE L30M KIT	<table border="1"> <thead> <tr> <th>Code</th> <th>Description</th> <th>Qty</th> <th>UOM</th> </tr> </thead> <tbody> <tr> <td>TB1818A0</td> <td>8X4.75 BLUE PE WATER INLET PIPE</td> <td>30</td> <td>M</td> </tr> </tbody> </table>	Code	Description	Qty	UOM	TB1818A0	8X4.75 BLUE PE WATER INLET PIPE	30	M																												
Code	Description	Qty	UOM																																						
TB1818A0	8X4.75 BLUE PE WATER INLET PIPE	30	M																																						
VL1053B			KVL0001A	LM TOP WASHING SYSTEM CIRCUIT KI	<table border="1"> <thead> <tr> <th>Code</th> <th>Description</th> <th>Qty</th> <th>UOM</th> </tr> </thead> <tbody> <tr> <td>0H1226A0</td> <td>LINEMISSTOP WASHING SYTEM CIRCUIT COVE</td> <td>1</td> <td>PZ</td> </tr> <tr> <td>0H1226B0</td> <td>LINEMISSTOP WASHING SYTEM CIRCUIT COVE</td> <td>1</td> <td>PZ</td> </tr> <tr> <td>EL1180A0</td> <td>Ø8-Ø8 FEMALE NON-RETURN CONNECTION</td> <td>1</td> <td>PZ</td> </tr> <tr> <td>GN1312A0</td> <td>RUBBER CABLE-PASSI NG DE=26 DI=15 SP=10</td> <td>1</td> <td>PZ</td> </tr> <tr> <td>GN1526A0</td> <td>INT. D.=6.9 TH=1.8 O-RIN</td> <td>1</td> <td>PZ</td> </tr> <tr> <td>RC1008A0</td> <td>D9 ELASTIC CLIP</td> <td>3</td> <td>PZ</td> </tr> <tr> <td>RC1019A0</td> <td>D=10 ELASTIC CLAMP</td> <td>3</td> <td>PZ</td> </tr> <tr> <td>RC1242A0</td> <td>D=10 CLOSED CAP</td> <td>2</td> <td>PZ</td> </tr> </tbody> </table>	Code	Description	Qty	UOM	0H1226A0	LINEMISSTOP WASHING SYTEM CIRCUIT COVE	1	PZ	0H1226B0	LINEMISSTOP WASHING SYTEM CIRCUIT COVE	1	PZ	EL1180A0	Ø8-Ø8 FEMALE NON-RETURN CONNECTION	1	PZ	GN1312A0	RUBBER CABLE-PASSI NG DE=26 DI=15 SP=10	1	PZ	GN1526A0	INT. D.=6.9 TH=1.8 O-RIN	1	PZ	RC1008A0	D9 ELASTIC CLIP	3	PZ	RC1019A0	D=10 ELASTIC CLAMP	3	PZ	RC1242A0	D=10 CLOSED CAP	2	PZ
Code	Description	Qty	UOM																																						
0H1226A0	LINEMISSTOP WASHING SYTEM CIRCUIT COVE	1	PZ																																						
0H1226B0	LINEMISSTOP WASHING SYTEM CIRCUIT COVE	1	PZ																																						
EL1180A0	Ø8-Ø8 FEMALE NON-RETURN CONNECTION	1	PZ																																						
GN1312A0	RUBBER CABLE-PASSI NG DE=26 DI=15 SP=10	1	PZ																																						
GN1526A0	INT. D.=6.9 TH=1.8 O-RIN	1	PZ																																						
RC1008A0	D9 ELASTIC CLIP	3	PZ																																						
RC1019A0	D=10 ELASTIC CLAMP	3	PZ																																						
RC1242A0	D=10 CLOSED CAP	2	PZ																																						

COMPONENT			SPARE PART																																																																														
Code	Description	Image	Code	Description	Components list																																																																												
VL1053B			KVL0001A	LM TOP WASHING SYSTEM CIRCUIT KI	<table border="1"> <thead> <tr> <th>Code</th> <th>Description</th> <th>Qty</th> <th>UOM</th> </tr> </thead> <tbody> <tr> <td>RC1381A0</td> <td>BIFILAR PIPE CLIP D10.7</td> <td>3</td> <td>PZ</td> </tr> <tr> <td>RC1408A0</td> <td>DOUBLE WIRE SPRING CLAMP D10.8 ZN</td> <td>2</td> <td>PZ</td> </tr> <tr> <td>TB2343A0</td> <td>9X6 PVC TRANSPAREN T PIPE</td> <td>2.630</td> <td>M</td> </tr> <tr> <td>TB2820A0</td> <td>PIPE EPDM FOR WASHING SYSTEM</td> <td>0.990</td> <td>M</td> </tr> <tr> <td>VI1220A1</td> <td>4,2X12 TCB SELF-TAPPIN G SCREW</td> <td>1</td> <td>PZ</td> </tr> <tr> <td>VL1019A0</td> <td>VIBRATION PUMP</td> <td>1</td> <td>PZ</td> </tr> <tr> <td>VL1041C0</td> <td>DETERGENT CAP WITH Ø12 HOLE</td> <td>1</td> <td>PZ</td> </tr> <tr> <td>VL1047A1</td> <td>D6 PIPE HOLDER - D8 J.G. TERMINAL</td> <td>1</td> <td>PZ</td> </tr> <tr> <td>VL1053A1</td> <td></td> <td>1</td> <td>PZ</td> </tr> <tr> <td>VL1053B0</td> <td></td> <td>1</td> <td>PZ</td> </tr> <tr> <td>VL1054A1</td> <td></td> <td>1</td> <td>PZ</td> </tr> <tr> <td>VL1054B0</td> <td></td> <td>1</td> <td>PZ</td> </tr> <tr> <td>VL1061A0</td> <td>HOLD DOWN WEIGHT+NET FILTER+NON-RET. V.</td> <td>1</td> <td>PZ</td> </tr> <tr> <td>VL1081A0</td> <td>D6 BARBED NO RETURN VALVE</td> <td>1</td> <td>PZ</td> </tr> <tr> <td>VM1066A0</td> <td>SADDLE CLIP FOR CABLES PASSING</td> <td>3</td> <td>PZ</td> </tr> <tr> <td>VM1088A0</td> <td>NYLON CLICK CLAMP D7.9-D9.2</td> <td>1</td> <td>PZ</td> </tr> <tr> <td>VM1605A0</td> <td>CLIP TWIST LOCK DIAM. 10.2-12.7 MM</td> <td>1</td> <td>PZ</td> </tr> <tr> <td>VM2172A0</td> <td>PUMP LOCKING CLIP</td> <td>1</td> <td>PZ</td> </tr> </tbody> </table>	Code	Description	Qty	UOM	RC1381A0	BIFILAR PIPE CLIP D10.7	3	PZ	RC1408A0	DOUBLE WIRE SPRING CLAMP D10.8 ZN	2	PZ	TB2343A0	9X6 PVC TRANSPAREN T PIPE	2.630	M	TB2820A0	PIPE EPDM FOR WASHING SYSTEM	0.990	M	VI1220A1	4,2X12 TCB SELF-TAPPIN G SCREW	1	PZ	VL1019A0	VIBRATION PUMP	1	PZ	VL1041C0	DETERGENT CAP WITH Ø12 HOLE	1	PZ	VL1047A1	D6 PIPE HOLDER - D8 J.G. TERMINAL	1	PZ	VL1053A1		1	PZ	VL1053B0		1	PZ	VL1054A1		1	PZ	VL1054B0		1	PZ	VL1061A0	HOLD DOWN WEIGHT+NET FILTER+NON-RET. V.	1	PZ	VL1081A0	D6 BARBED NO RETURN VALVE	1	PZ	VM1066A0	SADDLE CLIP FOR CABLES PASSING	3	PZ	VM1088A0	NYLON CLICK CLAMP D7.9-D9.2	1	PZ	VM1605A0	CLIP TWIST LOCK DIAM. 10.2-12.7 MM	1	PZ	VM2172A0	PUMP LOCKING CLIP	1	PZ
Code	Description	Qty	UOM																																																																														
RC1381A0	BIFILAR PIPE CLIP D10.7	3	PZ																																																																														
RC1408A0	DOUBLE WIRE SPRING CLAMP D10.8 ZN	2	PZ																																																																														
TB2343A0	9X6 PVC TRANSPAREN T PIPE	2.630	M																																																																														
TB2820A0	PIPE EPDM FOR WASHING SYSTEM	0.990	M																																																																														
VI1220A1	4,2X12 TCB SELF-TAPPIN G SCREW	1	PZ																																																																														
VL1019A0	VIBRATION PUMP	1	PZ																																																																														
VL1041C0	DETERGENT CAP WITH Ø12 HOLE	1	PZ																																																																														
VL1047A1	D6 PIPE HOLDER - D8 J.G. TERMINAL	1	PZ																																																																														
VL1053A1		1	PZ																																																																														
VL1053B0		1	PZ																																																																														
VL1054A1		1	PZ																																																																														
VL1054B0		1	PZ																																																																														
VL1061A0	HOLD DOWN WEIGHT+NET FILTER+NON-RET. V.	1	PZ																																																																														
VL1081A0	D6 BARBED NO RETURN VALVE	1	PZ																																																																														
VM1066A0	SADDLE CLIP FOR CABLES PASSING	3	PZ																																																																														
VM1088A0	NYLON CLICK CLAMP D7.9-D9.2	1	PZ																																																																														
VM1605A0	CLIP TWIST LOCK DIAM. 10.2-12.7 MM	1	PZ																																																																														
VM2172A0	PUMP LOCKING CLIP	1	PZ																																																																														



COMPONENT			SPARE PART										
Code	Description	Image	Code	Description	Components list								
EL1436A			KEL1436A	D8 CONNECTION D6 SOLEN.VALVE KIT	<table border="1"> <thead> <tr> <th>Code</th> <th>Description</th> <th>Qty</th> <th>UOM</th> </tr> </thead> <tbody> <tr> <td>EL1436A0</td> <td></td> <td>1</td> <td>PZ</td> </tr> </tbody> </table>	Code	Description	Qty	UOM	EL1436A0		1	PZ
Code	Description	Qty	UOM										
EL1436A0		1	PZ										
RC1408A	DOUBLE WIRE SPRING CLAMP D10.8 ZN		KRC1408A	4 PCS D10.8 DOUBLE WIRE SPRING CLAMP KIT	<table border="1"> <thead> <tr> <th>Code</th> <th>Description</th> <th>Qty</th> <th>UOM</th> </tr> </thead> <tbody> <tr> <td>RC1408A0</td> <td>DOUBLE WIRE SPRING CLAMP D10.8 ZN</td> <td>4</td> <td>PZ</td> </tr> </tbody> </table>	Code	Description	Qty	UOM	RC1408A0	DOUBLE WIRE SPRING CLAMP D10.8 ZN	4	PZ
Code	Description	Qty	UOM										
RC1408A0	DOUBLE WIRE SPRING CLAMP D10.8 ZN	4	PZ										
TB3196A			TB3196A0										
TB3195A			TB3195A0										
TB3114A			TB3114A0										



COMPONENT			SPARE PART		
<i>Code</i>	<i>Description</i>	<i>Image</i>	<i>Code</i>	<i>Description</i>	<i>Components list</i>
0E1350A	GN1-1 XEVC EXTERNAL BOTTOM PANEL		0E1350A1	GN1-1 XEVC EXTERNAL BOTTOM PANEL	



**ASM2926A/0.D01 - Electrical system**

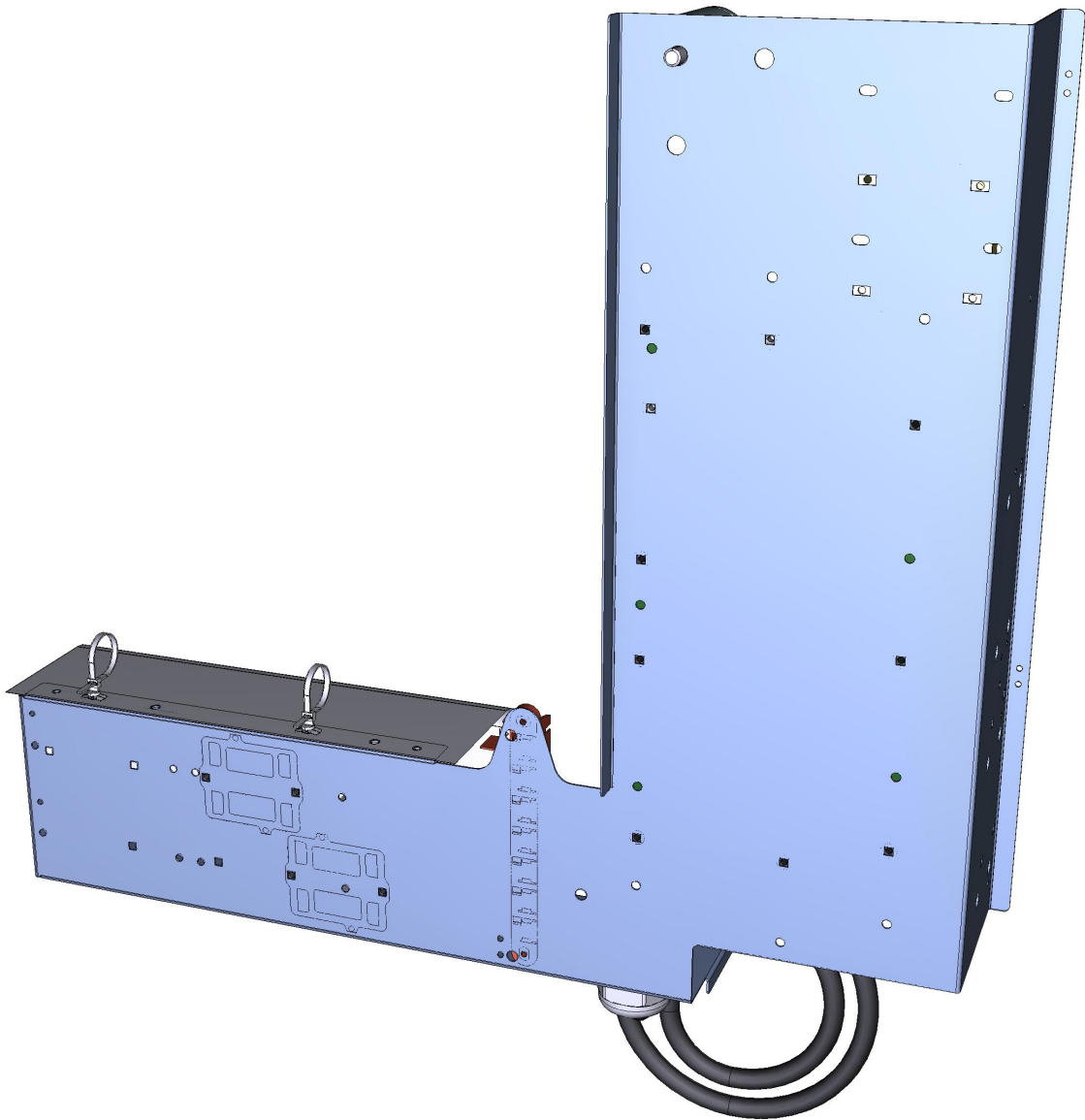

**FRONT**

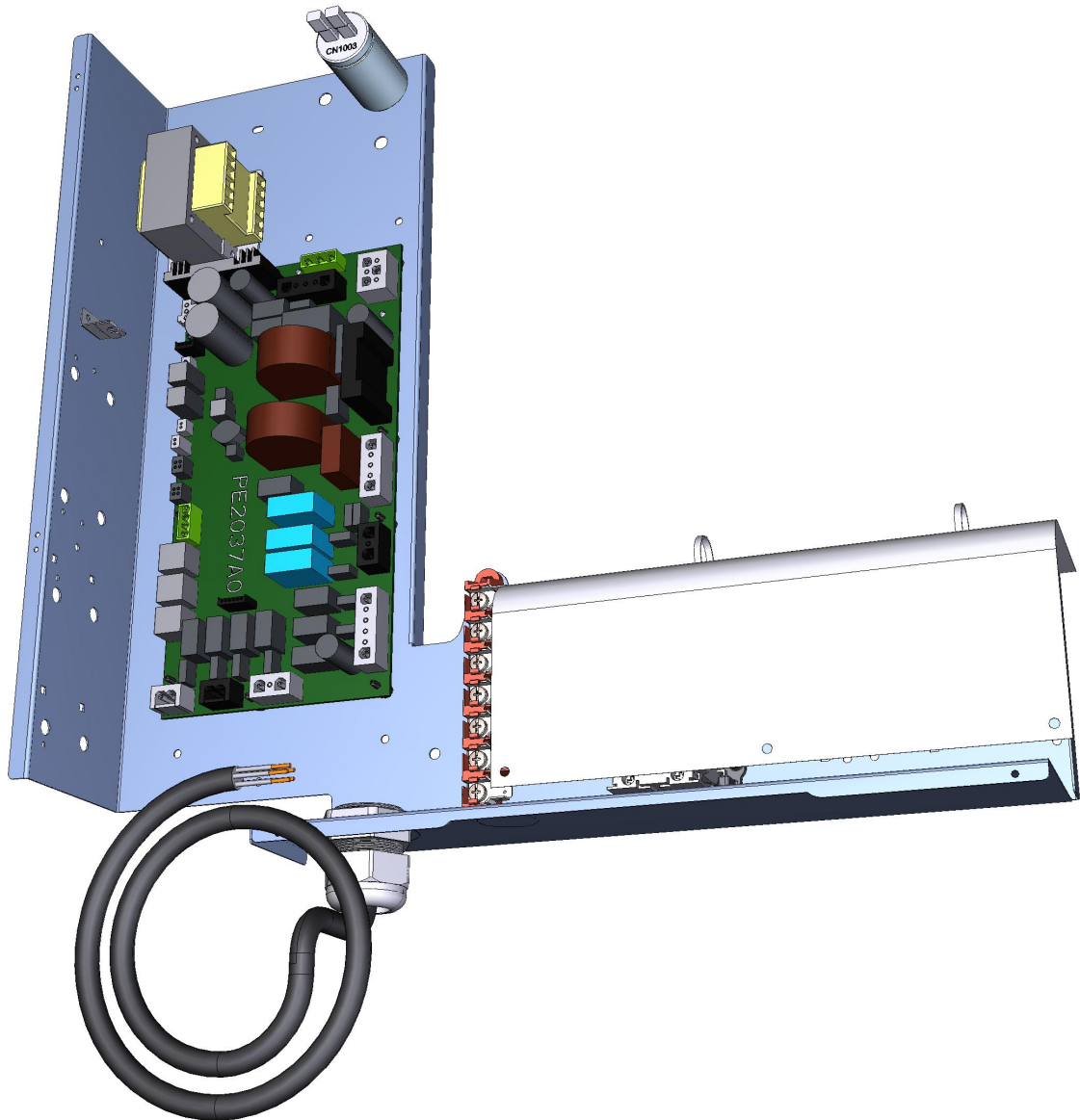

ASM2926A/0.D01 - Electrical system

REAR

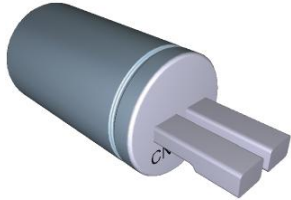
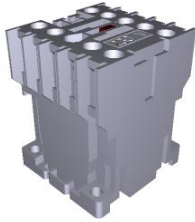

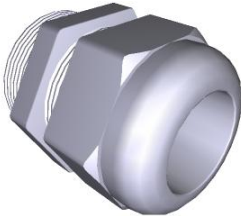
COMPONENT			SPARE PART																		
Code	Description	Image	Code	Description	Components list																
CN1003A	6,3 UF MOTOR CAPACITOR		KCN1003A	MOTOR CAPACITOR KIT	<table border="1"> <thead> <tr> <th>Code</th> <th>Description</th> <th>Qty</th> <th>UOM</th> </tr> </thead> <tbody> <tr> <td>CN1003A0</td> <td>6,3 UF MOTOR CAPACITOR</td> <td>1</td> <td>PZ</td> </tr> <tr> <td>VI1931A0</td> <td>M8 NUT+INDENTE D WASHER D=8 X COND.</td> <td>1</td> <td>PZ</td> </tr> <tr> <td>VI1932A0</td> <td>M8 NUT+INDENTE D WASHER D=8 X COND.</td> <td>1</td> <td>PZ</td> </tr> </tbody> </table>	Code	Description	Qty	UOM	CN1003A0	6,3 UF MOTOR CAPACITOR	1	PZ	VI1931A0	M8 NUT+INDENTE D WASHER D=8 X COND.	1	PZ	VI1932A0	M8 NUT+INDENTE D WASHER D=8 X COND.	1	PZ
					Code	Description	Qty	UOM													
CN1003A0	6,3 UF MOTOR CAPACITOR	1	PZ																		
VI1931A0	M8 NUT+INDENTE D WASHER D=8 X COND.	1	PZ																		
VI1932A0	M8 NUT+INDENTE D WASHER D=8 X COND.	1	PZ																		
VE1115A	20 A 230V 4 POLES MINICONTACTOR		KVE1115A	20A 230V 4 POLES MINICONTACTOR KI	<table border="1"> <thead> <tr> <th>Code</th> <th>Description</th> <th>Qty</th> <th>UOM</th> </tr> </thead> <tbody> <tr> <td>VE1115A0</td> <td>20 A 230V 4 POLES MINICONTACTOR</td> <td>1</td> <td>PZ</td> </tr> <tr> <td>VM1075A1</td> <td>PLASTIC CLIP TO FIX CONTACTORS</td> <td>4</td> <td>PZ</td> </tr> </tbody> </table>	Code	Description	Qty	UOM	VE1115A0	20 A 230V 4 POLES MINICONTACTOR	1	PZ	VM1075A1	PLASTIC CLIP TO FIX CONTACTORS	4	PZ				
Code	Description	Qty	UOM																		
VE1115A0	20 A 230V 4 POLES MINICONTACTOR	1	PZ																		
VM1075A1	PLASTIC CLIP TO FIX CONTACTORS	4	PZ																		
VM1056A	SMALL CONTACTOR BRACKET VE1115A		VM1056A0	SMALL CONTACTOR BRACKET VE1115A																	
MR1004A	41A 450V 7 POLES TERMINAL		KMR1004A	7FTW 1+2+3/4+5+6 TERMINAL BLOCK KIT	<table border="1"> <thead> <tr> <th>Code</th> <th>Description</th> <th>Qty</th> <th>UOM</th> </tr> </thead> <tbody> <tr> <td>MR1004A1</td> <td>41A 450V 7 POLES TERMINAL</td> <td>1</td> <td>PZ</td> </tr> </tbody> </table>	Code	Description	Qty	UOM	MR1004A1	41A 450V 7 POLES TERMINAL	1	PZ								
Code	Description	Qty	UOM																		
MR1004A1	41A 450V 7 POLES TERMINAL	1	PZ																		
VE1645A	PG 29 STRAIN RELIEF																				

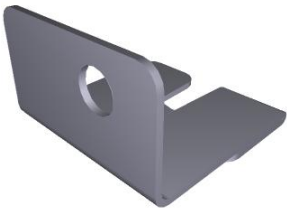
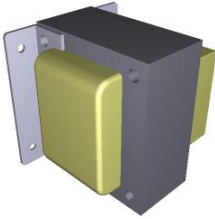
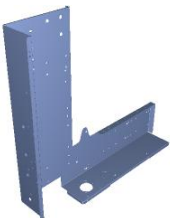

COMPONENT			SPARE PART																		
Code	Description	Image	Code	Description	Components list																
VE1644A	PG 29 STRAIN RELIEF NUT		VE1644A0	PG 29 STRAIN RELIEF NUT																	
0H7374A	CORE PROBE CABLE PLATE		0H7374A0	CORE PROBE CABLE PLATE																	
VE1639A			KVE1639A	230-12VAC 60VA TRANSFORMER KIT	<table border="1"> <thead> <tr> <th>Code</th> <th>Description</th> <th>Qty</th> <th>UOM</th> </tr> </thead> <tbody> <tr> <td>VE1639A0</td> <td></td> <td>1</td> <td>PZ</td> </tr> <tr> <td>VI1950A0</td> <td>ST. STEEL 4,2X13 TCB SELF-DRILLIN G SCREW</td> <td>4</td> <td>PZ</td> </tr> <tr> <td>VM2147A0</td> <td>ESD SPONGE PINK SMOOTH 410X343X15 M</td> <td>1</td> <td>PZ</td> </tr> </tbody> </table>	Code	Description	Qty	UOM	VE1639A0		1	PZ	VI1950A0	ST. STEEL 4,2X13 TCB SELF-DRILLIN G SCREW	4	PZ	VM2147A0	ESD SPONGE PINK SMOOTH 410X343X15 M	1	PZ
Code	Description	Qty	UOM																		
VE1639A0		1	PZ																		
VI1950A0	ST. STEEL 4,2X13 TCB SELF-DRILLIN G SCREW	4	PZ																		
VM2147A0	ESD SPONGE PINK SMOOTH 410X343X15 M	1	PZ																		
0H7250A	MM ONE GN1/1 ELECT. COMPONENTS HOLDER		0H7250A0	MM ONE GN1/1 ELECT. COMPONENTS HOLDER																	

**ASM2921A/0.D01 - Door**

**FRONT**

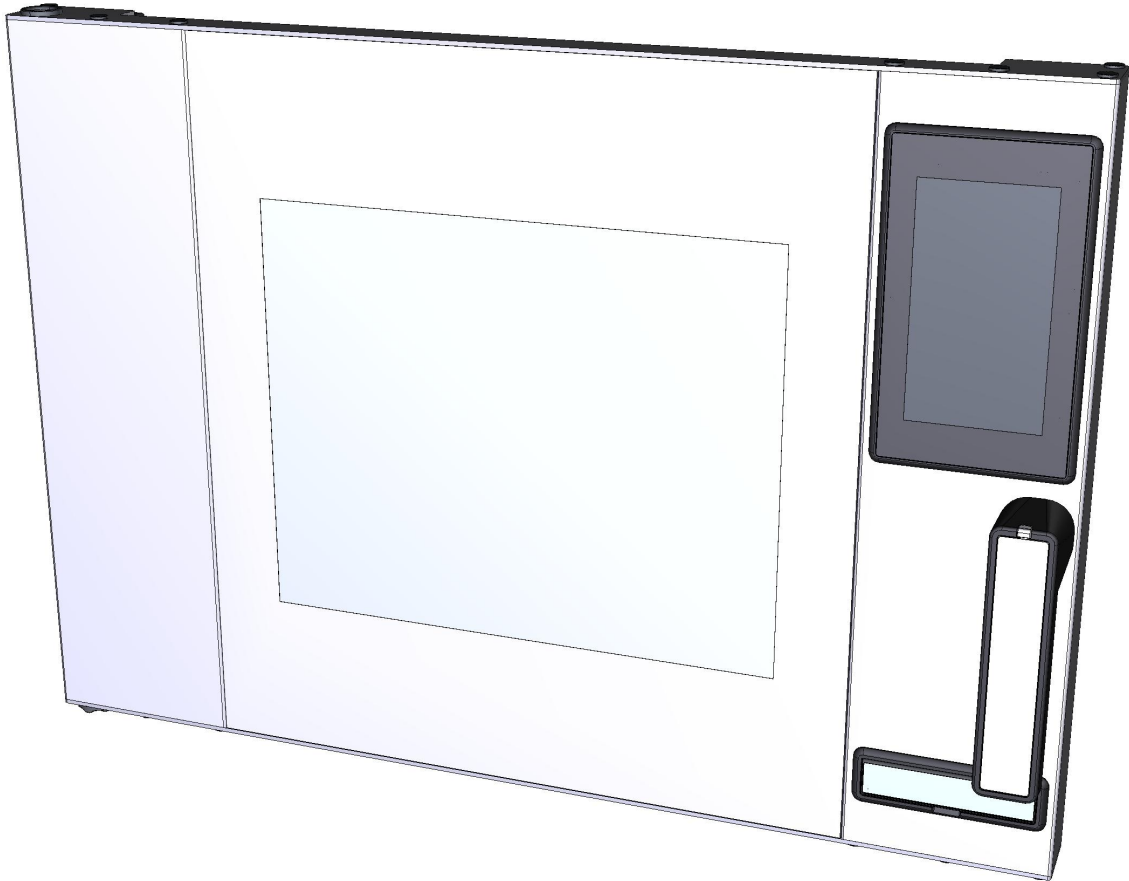

**ASM2921A/0.D01 - Door**

**REAR**

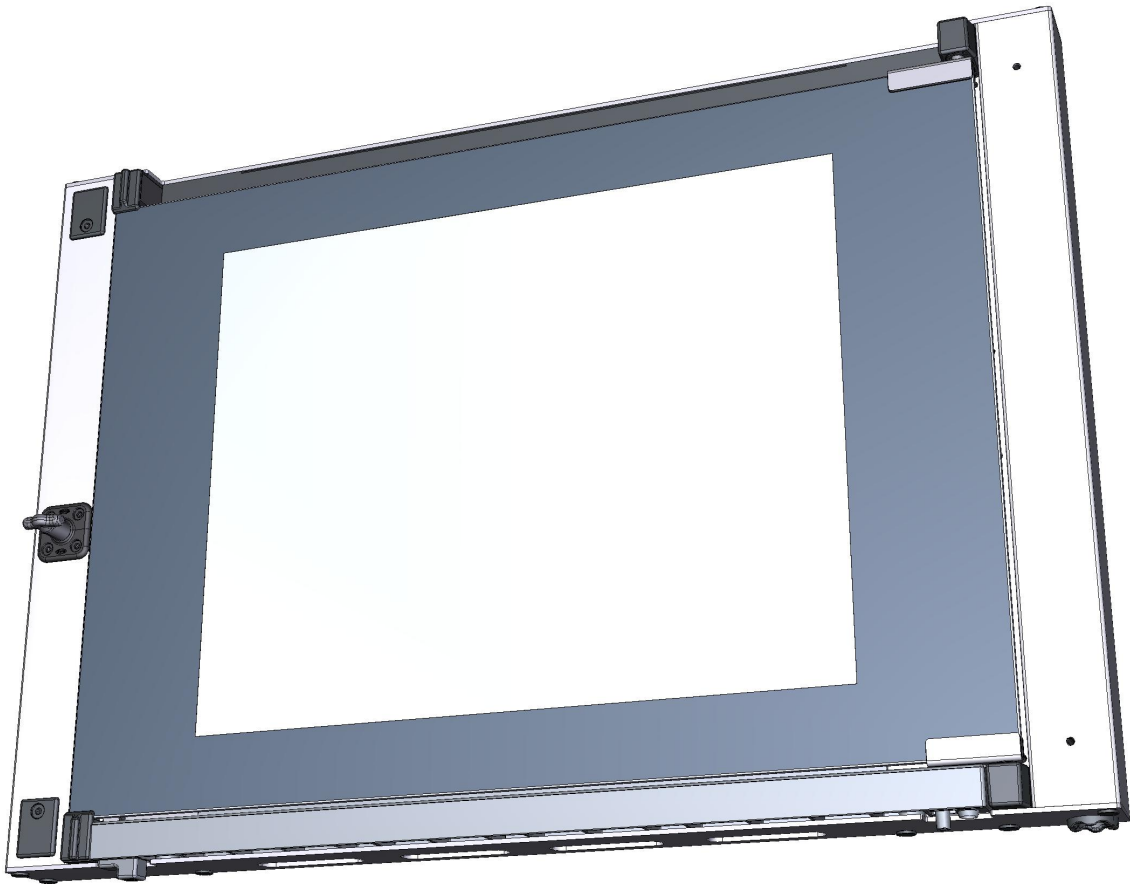

COMPONENT			SPARE PART																																																						
Code	Description	Image	Code	Description	Components list																																																				
VT1276A	XEVC-0511-E DOOR EXTERNAL GLASS		KVT1276A	0511 EXTERNAL GLASS KIT	<table border="1"> <thead> <tr> <th>Code</th> <th>Description</th> <th>Qty</th> <th>UOM</th> </tr> </thead> <tbody> <tr> <td>0B1166A0</td> <td>EXTERNAL GLASS SUPPORT PROFILE</td> <td>2</td> <td>PZ</td> </tr> <tr> <td>IP1508A0</td> <td></td> <td>1</td> <td>PZ</td> </tr> <tr> <td>IP1508A1</td> <td></td> <td>1</td> <td>M</td> </tr> <tr> <td>SL1155A1</td> <td>SILICON BICOMPONEN T LOCTITE</td> <td>150</td> <td>ML</td> </tr> <tr> <td>SL1156A0</td> <td>NOZZLE FOR SILICON GUN</td> <td>1</td> <td>PZ</td> </tr> <tr> <td>VM1059A1</td> <td></td> <td>1.500</td> <td>M</td> </tr> <tr> <td>VT1276A0</td> <td>XEVC-0511-E DOOR EXTERNAL GLASS</td> <td>1</td> <td>PZ</td> </tr> </tbody> </table>	Code	Description	Qty	UOM	0B1166A0	EXTERNAL GLASS SUPPORT PROFILE	2	PZ	IP1508A0		1	PZ	IP1508A1		1	M	SL1155A1	SILICON BICOMPONEN T LOCTITE	150	ML	SL1156A0	NOZZLE FOR SILICON GUN	1	PZ	VM1059A1		1.500	M	VT1276A0	XEVC-0511-E DOOR EXTERNAL GLASS	1	PZ																				
Code	Description	Qty	UOM																																																						
0B1166A0	EXTERNAL GLASS SUPPORT PROFILE	2	PZ																																																						
IP1508A0		1	PZ																																																						
IP1508A1		1	M																																																						
SL1155A1	SILICON BICOMPONEN T LOCTITE	150	ML																																																						
SL1156A0	NOZZLE FOR SILICON GUN	1	PZ																																																						
VM1059A1		1.500	M																																																						
VT1276A0	XEVC-0511-E DOOR EXTERNAL GLASS	1	PZ																																																						
MG1083A	6 SERIES DOOR COMPLETE HANDLE		KMG1083A	MM SERIES COMPLETE HANDLE KIT	<table border="1"> <thead> <tr> <th>Code</th> <th>Description</th> <th>Qty</th> <th>UOM</th> </tr> </thead> <tbody> <tr> <td>0H7321A0</td> <td>MM STAINLESS STEEL HANDLE COVE</td> <td>1</td> <td>PZ</td> </tr> <tr> <td>RC1200A0</td> <td>ED=4 WIRE D.=0.5 COMPRESSIO N SPRING</td> <td>4</td> <td>PZ</td> </tr> <tr> <td>VI0239A1</td> <td></td> <td>4</td> <td>PZ</td> </tr> <tr> <td>VI1220A1</td> <td>4,2X12 TCB SELF-TAPPIN G SCREW</td> <td>2</td> <td>PZ</td> </tr> <tr> <td>VM1182B0</td> <td>E.S. CT BT HANDLE JUNCTION + PIN GUIDE</td> <td>1</td> <td>PZ</td> </tr> <tr> <td>VM1183A1</td> <td>CHEFTOP/BAK ERTOP HANDLE PIN</td> <td>1</td> <td>PZ</td> </tr> <tr> <td>VM1490A0</td> <td>CHEFTOP/BAK ERTOP HANDLE SCREWS COVER</td> <td>2</td> <td>PZ</td> </tr> <tr> <td>VM1695A0</td> <td>HANDLE POSITION PIN</td> <td>4</td> <td>PZ</td> </tr> <tr> <td>VM2245A0</td> <td>HANDLE SHAFT WITH LATCH</td> <td>1</td> <td>PZ</td> </tr> <tr> <td>VM2247A0</td> <td>HANDLE SHAFT COVER VM2245-2246</td> <td>1</td> <td>PZ</td> </tr> <tr> <td>VM2248A0</td> <td>CLOSING HANDLE KEY WITH LATCH</td> <td>1</td> <td>PZ</td> </tr> <tr> <td>VM2295A0</td> <td>STYLUS PEN FOR MM</td> <td>1</td> <td>PZ</td> </tr> </tbody> </table>	Code	Description	Qty	UOM	0H7321A0	MM STAINLESS STEEL HANDLE COVE	1	PZ	RC1200A0	ED=4 WIRE D.=0.5 COMPRESSIO N SPRING	4	PZ	VI0239A1		4	PZ	VI1220A1	4,2X12 TCB SELF-TAPPIN G SCREW	2	PZ	VM1182B0	E.S. CT BT HANDLE JUNCTION + PIN GUIDE	1	PZ	VM1183A1	CHEFTOP/BAK ERTOP HANDLE PIN	1	PZ	VM1490A0	CHEFTOP/BAK ERTOP HANDLE SCREWS COVER	2	PZ	VM1695A0	HANDLE POSITION PIN	4	PZ	VM2245A0	HANDLE SHAFT WITH LATCH	1	PZ	VM2247A0	HANDLE SHAFT COVER VM2245-2246	1	PZ	VM2248A0	CLOSING HANDLE KEY WITH LATCH	1	PZ	VM2295A0	STYLUS PEN FOR MM	1	PZ
Code	Description	Qty	UOM																																																						
0H7321A0	MM STAINLESS STEEL HANDLE COVE	1	PZ																																																						
RC1200A0	ED=4 WIRE D.=0.5 COMPRESSIO N SPRING	4	PZ																																																						
VI0239A1		4	PZ																																																						
VI1220A1	4,2X12 TCB SELF-TAPPIN G SCREW	2	PZ																																																						
VM1182B0	E.S. CT BT HANDLE JUNCTION + PIN GUIDE	1	PZ																																																						
VM1183A1	CHEFTOP/BAK ERTOP HANDLE PIN	1	PZ																																																						
VM1490A0	CHEFTOP/BAK ERTOP HANDLE SCREWS COVER	2	PZ																																																						
VM1695A0	HANDLE POSITION PIN	4	PZ																																																						
VM2245A0	HANDLE SHAFT WITH LATCH	1	PZ																																																						
VM2247A0	HANDLE SHAFT COVER VM2245-2246	1	PZ																																																						
VM2248A0	CLOSING HANDLE KEY WITH LATCH	1	PZ																																																						
VM2295A0	STYLUS PEN FOR MM	1	PZ																																																						



COMPONENT			SPARE PART																		
Code	Description	Image	Code	Description	Components list																
VM2274A	GROOVED BUSHING		KVM2274A	GROOVED PIN BUSHING KIT	<table border="1"> <thead> <tr> <th>Code</th> <th>Description</th> <th>Qty</th> <th>UOM</th> </tr> </thead> <tbody> <tr> <td>VM2274A0</td> <td>GROOVED BUSHING</td> <td>1</td> <td>PZ</td> </tr> </tbody> </table>	Code	Description	Qty	UOM	VM2274A0	GROOVED BUSHING	1	PZ								
Code	Description	Qty	UOM																		
VM2274A0	GROOVED BUSHING	1	PZ																		
VM2305A	6 SERIES DOOR CAP FIXING PAWL		VM2305A0	6 SERIES DOOR CAP FIXING PAWL																	
VM2259A			KVM2259A	MIND MAPS DOOR LEFT LOWER CAP KI	<table border="1"> <thead> <tr> <th>Code</th> <th>Description</th> <th>Qty</th> <th>UOM</th> </tr> </thead> <tbody> <tr> <td>V11996A0</td> <td>M5X35 SCREW</td> <td>3</td> <td>PZ</td> </tr> <tr> <td>VM2259A1</td> <td></td> <td>1</td> <td>PZ</td> </tr> <tr> <td>VM2305A0</td> <td>6 SERIES DOOR CAP FIXING PAWL</td> <td>3</td> <td>PZ</td> </tr> </tbody> </table>	Code	Description	Qty	UOM	V11996A0	M5X35 SCREW	3	PZ	VM2259A1		1	PZ	VM2305A0	6 SERIES DOOR CAP FIXING PAWL	3	PZ
Code	Description	Qty	UOM																		
V11996A0	M5X35 SCREW	3	PZ																		
VM2259A1		1	PZ																		
VM2305A0	6 SERIES DOOR CAP FIXING PAWL	3	PZ																		
VM2305A	6 SERIES DOOR CAP FIXING PAWL		VM2305A0	6 SERIES DOOR CAP FIXING PAWL																	
VM2275A	SMOOTH BUSHING		KVM2275A	SMOOTH PIN BUSHING KIT	<table border="1"> <thead> <tr> <th>Code</th> <th>Description</th> <th>Qty</th> <th>UOM</th> </tr> </thead> <tbody> <tr> <td>VM2275A0</td> <td>SMOOTH BUSHING</td> <td>1</td> <td>PZ</td> </tr> </tbody> </table>	Code	Description	Qty	UOM	VM2275A0	SMOOTH BUSHING	1	PZ								
Code	Description	Qty	UOM																		
VM2275A0	SMOOTH BUSHING	1	PZ																		







COMPONENT			SPARE PART														
Code	Description	Image	Code	Description	Components list												
VM2260A																	
VM2305A	6 SERIES DOOR CAP FIXING PAWL		VM2305A0	6 SERIES DOOR CAP FIXING PAWL													
VM2267A	INTERNAL GLASS LOCKING SYSTEM SLIDER		VM2267A0	INTERNAL GLASS LOCKING SYSTEM SLIDER													
VM2269A	INTERNAL GLASS LOCKING SYSTEM CAP		KVM2269A	INNER GLASS FIXING CAP KIT	<table border="1"> <thead> <tr> <th>Code</th> <th>Description</th> <th>Qty</th> <th>UOM</th> </tr> </thead> <tbody> <tr> <td>VM2269A0</td> <td>INTERNAL GLASS LOCKING SYSTEM CAP</td> <td>2</td> <td>PZ</td> </tr> </tbody> </table>	Code	Description	Qty	UOM	VM2269A0	INTERNAL GLASS LOCKING SYSTEM CAP	2	PZ				
Code	Description	Qty	UOM														
VM2269A0	INTERNAL GLASS LOCKING SYSTEM CAP	2	PZ														
VE1030A	MAGNET FOR DOOR MICROSWITCH D=22,9MM		KVE1030A	2 PCS MAGNET KIT FOR DOOR SWITCH	<table border="1"> <thead> <tr> <th>Code</th> <th>Description</th> <th>Qty</th> <th>UOM</th> </tr> </thead> <tbody> <tr> <td>VE1030A1</td> <td>MAGNET FOR DOOR MICROSWITC H D=22,9MM</td> <td>2</td> <td>PZ</td> </tr> </tbody> </table>	Code	Description	Qty	UOM	VE1030A1	MAGNET FOR DOOR MICROSWITC H D=22,9MM	2	PZ				
Code	Description	Qty	UOM														
VE1030A1	MAGNET FOR DOOR MICROSWITC H D=22,9MM	2	PZ														
			KVE1020A	MICROSWITCH KIT	<table border="1"> <thead> <tr> <th>Code</th> <th>Description</th> <th>Qty</th> <th>UOM</th> </tr> </thead> <tbody> <tr> <td>VE1020A2</td> <td>MAGNETIC DOOR MICROSWITC</td> <td>1</td> <td>PZ</td> </tr> <tr> <td>VE1030A1</td> <td>MAGNET FOR DOOR MICROSWITC H D=22,9MM</td> <td>4</td> <td>PZ</td> </tr> </tbody> </table>	Code	Description	Qty	UOM	VE1020A2	MAGNETIC DOOR MICROSWITC	1	PZ	VE1030A1	MAGNET FOR DOOR MICROSWITC H D=22,9MM	4	PZ
Code	Description	Qty	UOM														
VE1020A2	MAGNETIC DOOR MICROSWITC	1	PZ														
VE1030A1	MAGNET FOR DOOR MICROSWITC H D=22,9MM	4	PZ														







COMPONENT			SPARE PART										
Code	Description	Image	Code	Description	Components list								
VM2268A	DOOR MAGNET COVER		KVM2268A	DOOR MAGNET COVER KIT	<table border="1"> <thead> <tr> <th>Code</th> <th>Description</th> <th>Qty</th> <th>UOM</th> </tr> </thead> <tbody> <tr> <td>VM2268A0</td> <td>DOOR MAGNET COVER</td> <td>1</td> <td>PZ</td> </tr> </tbody> </table>	Code	Description	Qty	UOM	VM2268A0	DOOR MAGNET COVER	1	PZ
Code	Description	Qty	UOM										
VM2268A0	DOOR MAGNET COVER	1	PZ										
VM2262A			KVM2262A	MIND.MAPS DOOR RIGHT UPPER CAP KIT	<table border="1"> <thead> <tr> <th>Code</th> <th>Description</th> <th>Qty</th> <th>UOM</th> </tr> </thead> <tbody> <tr> <td>VM2262A1</td> <td></td> <td>1</td> <td>PZ</td> </tr> </tbody> </table>	Code	Description	Qty	UOM	VM2262A1		1	PZ
Code	Description	Qty	UOM										
VM2262A1		1	PZ										
VM2305A	6 SERIES DOOR CAP FIXING PAWL		VM2305A0	6 SERIES DOOR CAP FIXING PAWL									
VM2267A	INTERNAL GLASS LOCKING SYSTEM SLIDER		VM2267A0	INTERNAL GLASS LOCKING SYSTEM SLIDER									
VM2269A	INTERNAL GLASS LOCKING SYSTEM CAP		KVM2269A	INNER GLASS FIXING CAP KIT	<table border="1"> <thead> <tr> <th>Code</th> <th>Description</th> <th>Qty</th> <th>UOM</th> </tr> </thead> <tbody> <tr> <td>VM2269A0</td> <td>INTERNAL GLASS LOCKING SYSTEM CAP</td> <td>2</td> <td>PZ</td> </tr> </tbody> </table>	Code	Description	Qty	UOM	VM2269A0	INTERNAL GLASS LOCKING SYSTEM CAP	2	PZ
Code	Description	Qty	UOM										
VM2269A0	INTERNAL GLASS LOCKING SYSTEM CAP	2	PZ										

COMPONENT			SPARE PART																						
Code	Description	Image	Code	Description	Components list																				
VE1030A	MAGNET FOR DOOR MICROSWITCH D=22,9MM		KVE1030A	2 PCS MAGNET KIT FOR DOOR SWITCH	<table border="1"> <thead> <tr> <th>Code</th> <th>Description</th> <th>Qty</th> <th>UOM</th> </tr> </thead> <tbody> <tr> <td>VE1030A1</td> <td>MAGNET FOR DOOR MICROSWITC H D=22,9MM</td> <td>2</td> <td>PZ</td> </tr> </tbody> </table>	Code	Description	Qty	UOM	VE1030A1	MAGNET FOR DOOR MICROSWITC H D=22,9MM	2	PZ												
			Code	Description	Qty	UOM																			
VE1030A1	MAGNET FOR DOOR MICROSWITC H D=22,9MM	2	PZ																						
KVE1020A	MICROSWITCH KIT	<table border="1"> <thead> <tr> <th>Code</th> <th>Description</th> <th>Qty</th> <th>UOM</th> </tr> </thead> <tbody> <tr> <td>VE1020A2</td> <td>MAGNETIC DOOR MICROSWITC</td> <td>1</td> <td>PZ</td> </tr> <tr> <td>VE1030A1</td> <td>MAGNET FOR DOOR MICROSWITC H D=22,9MM</td> <td>4</td> <td>PZ</td> </tr> </tbody> </table>	Code	Description	Qty	UOM	VE1020A2	MAGNETIC DOOR MICROSWITC	1	PZ	VE1030A1	MAGNET FOR DOOR MICROSWITC H D=22,9MM	4	PZ											
Code	Description	Qty	UOM																						
VE1020A2	MAGNETIC DOOR MICROSWITC	1	PZ																						
VE1030A1	MAGNET FOR DOOR MICROSWITC H D=22,9MM	4	PZ																						
VM2268A	DOOR MAGNET COVER		KVM2268A	DOOR MAGNET COVER KIT	<table border="1"> <thead> <tr> <th>Code</th> <th>Description</th> <th>Qty</th> <th>UOM</th> </tr> </thead> <tbody> <tr> <td>VM2268A0</td> <td>DOOR MAGNET COVER</td> <td>1</td> <td>PZ</td> </tr> </tbody> </table>	Code	Description	Qty	UOM	VM2268A0	DOOR MAGNET COVER	1	PZ												
Code	Description	Qty	UOM																						
VM2268A0	DOOR MAGNET COVER	1	PZ																						
VM2261A			KVM2261A	MIND.MAPS DOOR RIGHT LOWER CAP KIT	<table border="1"> <thead> <tr> <th>Code</th> <th>Description</th> <th>Qty</th> <th>UOM</th> </tr> </thead> <tbody> <tr> <td>VM2261A1</td> <td></td> <td>1</td> <td>PZ</td> </tr> </tbody> </table>	Code	Description	Qty	UOM	VM2261A1		1	PZ												
Code	Description	Qty	UOM																						
VM2261A1		1	PZ																						
VT1280A	XEVC-0511-E INTERNAL GLASS		KVT1280A	0511 INTERNAL GLASS KIT	<table border="1"> <thead> <tr> <th>Code</th> <th>Description</th> <th>Qty</th> <th>UOM</th> </tr> </thead> <tbody> <tr> <td>IP1508A0</td> <td></td> <td>1</td> <td>PZ</td> </tr> <tr> <td>IP1508A1</td> <td></td> <td>1</td> <td>M</td> </tr> <tr> <td>VM1059A1</td> <td></td> <td>1.500</td> <td>M</td> </tr> <tr> <td>VT1280A0</td> <td>XEVC-0511-E INTERNAL GLASS</td> <td>1</td> <td>PZ</td> </tr> </tbody> </table>	Code	Description	Qty	UOM	IP1508A0		1	PZ	IP1508A1		1	M	VM1059A1		1.500	M	VT1280A0	XEVC-0511-E INTERNAL GLASS	1	PZ
					Code	Description	Qty	UOM																	
					IP1508A0		1	PZ																	
					IP1508A1		1	M																	
VM1059A1		1.500	M																						
VT1280A0	XEVC-0511-E INTERNAL GLASS	1	PZ																						
CR1103A	INTERNAL GLASS ST. STEEL UPPER HINGE		KCR1103A	INTERNAL GLASS UPPER HINGE KIT	<table border="1"> <thead> <tr> <th>Code</th> <th>Description</th> <th>Qty</th> <th>UOM</th> </tr> </thead> <tbody> <tr> <td>CR1103A0</td> <td>INTERNAL GLASS ST. STEEL UPPER HINGE</td> <td>1</td> <td>PZ</td> </tr> <tr> <td>GN1182A0</td> <td>INTERNAL GLASS HINGE CR1103-1104 SEAL</td> <td>1</td> <td>PZ</td> </tr> </tbody> </table>	Code	Description	Qty	UOM	CR1103A0	INTERNAL GLASS ST. STEEL UPPER HINGE	1	PZ	GN1182A0	INTERNAL GLASS HINGE CR1103-1104 SEAL	1	PZ								
					Code	Description	Qty	UOM																	
CR1103A0	INTERNAL GLASS ST. STEEL UPPER HINGE	1	PZ																						
GN1182A0	INTERNAL GLASS HINGE CR1103-1104 SEAL	1	PZ																						



COMPONENT			SPARE PART																						
Code	Description	Image	Code	Description	Components list																				
CR1103A	INTERNAL GLASS ST. STEEL UPPER HINGE		KCR1103A	INTERNAL GLASS UPPER HINGE KIT	<table border="1"> <thead> <tr> <th>Code</th> <th>Description</th> <th>Qty</th> <th>UOM</th> </tr> </thead> <tbody> <tr> <td>GN1182A1</td> <td>INTERNAL GLASS HINGE CR1103-1104 SEAL</td> <td>1</td> <td>PZ</td> </tr> <tr> <td>VI1810A0</td> <td>M6X6 STAINLESS STEEL FLATHEAD SCREW</td> <td>3</td> <td>PZ</td> </tr> </tbody> </table>	Code	Description	Qty	UOM	GN1182A1	INTERNAL GLASS HINGE CR1103-1104 SEAL	1	PZ	VI1810A0	M6X6 STAINLESS STEEL FLATHEAD SCREW	3	PZ								
Code	Description	Qty	UOM																						
GN1182A1	INTERNAL GLASS HINGE CR1103-1104 SEAL	1	PZ																						
VI1810A0	M6X6 STAINLESS STEEL FLATHEAD SCREW	3	PZ																						
GN1182A	INTERNAL GLASS HINGE CR1103-1104 SEAL		KGN1182A	INT. GLASS HINGE GASKET 2 PCS KIT	<table border="1"> <thead> <tr> <th>Code</th> <th>Description</th> <th>Qty</th> <th>UOM</th> </tr> </thead> <tbody> <tr> <td>GN1182A0</td> <td>INTERNAL GLASS HINGE CR1103-1104 SEAL</td> <td>2</td> <td>PZ</td> </tr> <tr> <td>GN1182A1</td> <td>INTERNAL GLASS HINGE CR1103-1104 SEAL</td> <td>2</td> <td>PZ</td> </tr> </tbody> </table>	Code	Description	Qty	UOM	GN1182A0	INTERNAL GLASS HINGE CR1103-1104 SEAL	2	PZ	GN1182A1	INTERNAL GLASS HINGE CR1103-1104 SEAL	2	PZ								
Code	Description	Qty	UOM																						
GN1182A0	INTERNAL GLASS HINGE CR1103-1104 SEAL	2	PZ																						
GN1182A1	INTERNAL GLASS HINGE CR1103-1104 SEAL	2	PZ																						
VM2399A			VM2399A0																						
CR1104A	INTERNAL GLASS ST. STEEL LOWER HINGE		KCR1104A	INTERNAL GLASS LOWER HINGE KIT	<table border="1"> <thead> <tr> <th>Code</th> <th>Description</th> <th>Qty</th> <th>UOM</th> </tr> </thead> <tbody> <tr> <td>CR1104A0</td> <td>INTERNAL GLASS ST. STEEL LOWER HINGE</td> <td>1</td> <td>PZ</td> </tr> <tr> <td>GN1182A0</td> <td>INTERNAL GLASS HINGE CR1103-1104 SEAL</td> <td>1</td> <td>PZ</td> </tr> <tr> <td>GN1182A1</td> <td>INTERNAL GLASS HINGE CR1103-1104 SEAL</td> <td>1</td> <td>PZ</td> </tr> <tr> <td>VI1810A0</td> <td>M6X6 STAINLESS STEEL FLATHEAD SCREW</td> <td>3</td> <td>PZ</td> </tr> </tbody> </table>	Code	Description	Qty	UOM	CR1104A0	INTERNAL GLASS ST. STEEL LOWER HINGE	1	PZ	GN1182A0	INTERNAL GLASS HINGE CR1103-1104 SEAL	1	PZ	GN1182A1	INTERNAL GLASS HINGE CR1103-1104 SEAL	1	PZ	VI1810A0	M6X6 STAINLESS STEEL FLATHEAD SCREW	3	PZ
Code	Description	Qty	UOM																						
CR1104A0	INTERNAL GLASS ST. STEEL LOWER HINGE	1	PZ																						
GN1182A0	INTERNAL GLASS HINGE CR1103-1104 SEAL	1	PZ																						
GN1182A1	INTERNAL GLASS HINGE CR1103-1104 SEAL	1	PZ																						
VI1810A0	M6X6 STAINLESS STEEL FLATHEAD SCREW	3	PZ																						





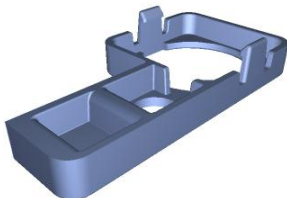
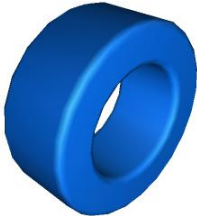

COMPONENT			SPARE PART																		
Code	Description	Image	Code	Description	Components list																
GN1182A	INTERNAL GLASS HINGE CR1103-1104 SEAL		KGN1182A	INT. GLASS HINGE GASKET 2 PCS KIT	<table border="1"> <thead> <tr> <th>Code</th> <th>Description</th> <th>Qty</th> <th>UOM</th> </tr> </thead> <tbody> <tr> <td>GN1182A0</td> <td>INTERNAL GLASS HINGE CR1103-1104 SEAL</td> <td>2</td> <td>PZ</td> </tr> <tr> <td>GN1182A1</td> <td>INTERNAL GLASS HINGE CR1103-1104 SEAL</td> <td>2</td> <td>PZ</td> </tr> </tbody> </table>	Code	Description	Qty	UOM	GN1182A0	INTERNAL GLASS HINGE CR1103-1104 SEAL	2	PZ	GN1182A1	INTERNAL GLASS HINGE CR1103-1104 SEAL	2	PZ				
					Code	Description	Qty	UOM													
GN1182A0	INTERNAL GLASS HINGE CR1103-1104 SEAL	2	PZ																		
GN1182A1	INTERNAL GLASS HINGE CR1103-1104 SEAL	2	PZ																		
VM2399A			VM2399A0																		
PE2046A	MM POWER SWITCH AND USB BOARD		KPE2046A	MIND.MAPS USB-RESET SUPPORT KIT	<table border="1"> <thead> <tr> <th>Code</th> <th>Description</th> <th>Qty</th> <th>UOM</th> </tr> </thead> <tbody> <tr> <td>PE2046A0</td> <td>MM POWER SWITCH AND USB BOARD</td> <td>1</td> <td>PZ</td> </tr> <tr> <td>VI1220A1</td> <td>4,2X12 TCB SELF-TAPPIN G SCREW</td> <td>2</td> <td>PZ</td> </tr> </tbody> </table>	Code	Description	Qty	UOM	PE2046A0	MM POWER SWITCH AND USB BOARD	1	PZ	VI1220A1	4,2X12 TCB SELF-TAPPIN G SCREW	2	PZ				
					Code	Description	Qty	UOM													
PE2046A0	MM POWER SWITCH AND USB BOARD	1	PZ																		
VI1220A1	4,2X12 TCB SELF-TAPPIN G SCREW	2	PZ																		
VM2315A	6 S. INTERNAL GLASS CAP SUPPORT		KVM2315A	MM INTERNAL GLASS SUPPORT KI	<table border="1"> <thead> <tr> <th>Code</th> <th>Description</th> <th>Qty</th> <th>UOM</th> </tr> </thead> <tbody> <tr> <td>VI1220A1</td> <td>4,2X12 TCB SELF-TAPPIN G SCREW</td> <td>3</td> <td>PZ</td> </tr> <tr> <td>VM1630A0</td> <td>INTERNAL GLASS PUSHING CAP</td> <td>3</td> <td>PZ</td> </tr> <tr> <td>VM2315A0</td> <td>6 S. INTERNAL GLASS CAP SUPPORT</td> <td>3</td> <td>PZ</td> </tr> </tbody> </table>	Code	Description	Qty	UOM	VI1220A1	4,2X12 TCB SELF-TAPPIN G SCREW	3	PZ	VM1630A0	INTERNAL GLASS PUSHING CAP	3	PZ	VM2315A0	6 S. INTERNAL GLASS CAP SUPPORT	3	PZ
Code	Description	Qty	UOM																		
VI1220A1	4,2X12 TCB SELF-TAPPIN G SCREW	3	PZ																		
VM1630A0	INTERNAL GLASS PUSHING CAP	3	PZ																		
VM2315A0	6 S. INTERNAL GLASS CAP SUPPORT	3	PZ																		
VM1630A	INTERNAL GLASS PUSHING CAP		KVM2315A	MM INTERNAL GLASS SUPPORT KI	<table border="1"> <thead> <tr> <th>Code</th> <th>Description</th> <th>Qty</th> <th>UOM</th> </tr> </thead> <tbody> <tr> <td>VI1220A1</td> <td>4,2X12 TCB SELF-TAPPIN G SCREW</td> <td>3</td> <td>PZ</td> </tr> <tr> <td>VM1630A0</td> <td>INTERNAL GLASS PUSHING CAP</td> <td>3</td> <td>PZ</td> </tr> <tr> <td>VM2315A0</td> <td>6 S. INTERNAL GLASS CAP SUPPORT</td> <td>3</td> <td>PZ</td> </tr> </tbody> </table>	Code	Description	Qty	UOM	VI1220A1	4,2X12 TCB SELF-TAPPIN G SCREW	3	PZ	VM1630A0	INTERNAL GLASS PUSHING CAP	3	PZ	VM2315A0	6 S. INTERNAL GLASS CAP SUPPORT	3	PZ
					Code	Description	Qty	UOM													
					VI1220A1	4,2X12 TCB SELF-TAPPIN G SCREW	3	PZ													
VM1630A0	INTERNAL GLASS PUSHING CAP	3	PZ																		
VM2315A0	6 S. INTERNAL GLASS CAP SUPPORT	3	PZ																		



COMPONENT			SPARE PART																		
Code	Description	Image	Code	Description	Components list																
VM1630A	INTERNAL GLASS PUSHING CAP		KVM1591A	S.5E INT. GLASS H35 PUSHING BRACKET KIT	<table border="1"> <thead> <tr> <th>Code</th> <th>Description</th> <th>Qty</th> <th>UOM</th> </tr> </thead> <tbody> <tr> <td>VI1220A1</td> <td>4,2X12 TCB SELF-TAPPIN G SCREW</td> <td>2</td> <td>PZ</td> </tr> <tr> <td>VM1591A0</td> <td>GLASS BRACKET INT. XVC1004</td> <td>1</td> <td>PZ</td> </tr> <tr> <td>VM1630A0</td> <td>INTERNAL GLASS PUSHING CAP</td> <td>2</td> <td>PZ</td> </tr> </tbody> </table>	Code	Description	Qty	UOM	VI1220A1	4,2X12 TCB SELF-TAPPIN G SCREW	2	PZ	VM1591A0	GLASS BRACKET INT. XVC1004	1	PZ	VM1630A0	INTERNAL GLASS PUSHING CAP	2	PZ
			Code	Description	Qty	UOM															
VI1220A1	4,2X12 TCB SELF-TAPPIN G SCREW	2	PZ																		
VM1591A0	GLASS BRACKET INT. XVC1004	1	PZ																		
VM1630A0	INTERNAL GLASS PUSHING CAP	2	PZ																		
KVM1590A	S.5 INT. GLASS H25 PUSHING BRACKET KIT	<table border="1"> <thead> <tr> <th>Code</th> <th>Description</th> <th>Qty</th> <th>UOM</th> </tr> </thead> <tbody> <tr> <td>VI1220A1</td> <td>4,2X12 TCB SELF-TAPPIN G SCREW</td> <td>2</td> <td>PZ</td> </tr> <tr> <td>VM1590A0</td> <td>XVC705 XBC805 GLASS PUSHING BRACKET</td> <td>1</td> <td>PZ</td> </tr> <tr> <td>VM1630A0</td> <td>INTERNAL GLASS PUSHING CAP</td> <td>2</td> <td>PZ</td> </tr> </tbody> </table>	Code	Description	Qty	UOM	VI1220A1	4,2X12 TCB SELF-TAPPIN G SCREW	2	PZ	VM1590A0	XVC705 XBC805 GLASS PUSHING BRACKET	1	PZ	VM1630A0	INTERNAL GLASS PUSHING CAP	2	PZ			
Code	Description	Qty	UOM																		
VI1220A1	4,2X12 TCB SELF-TAPPIN G SCREW	2	PZ																		
VM1590A0	XVC705 XBC805 GLASS PUSHING BRACKET	1	PZ																		
VM1630A0	INTERNAL GLASS PUSHING CAP	2	PZ																		
VM2284A	750 SERIES DRIP PROFILE		KVM2284A	750 SERIES DRIP PROFILE KIT	<table border="1"> <thead> <tr> <th>Code</th> <th>Description</th> <th>Qty</th> <th>UOM</th> </tr> </thead> <tbody> <tr> <td>VM2284A0</td> <td>750 SERIES DRIP PROFILE</td> <td>1</td> <td>PZ</td> </tr> </tbody> </table>	Code	Description	Qty	UOM	VM2284A0	750 SERIES DRIP PROFILE	1	PZ								
Code	Description	Qty	UOM																		
VM2284A0	750 SERIES DRIP PROFILE	1	PZ																		
VM2314A	6 S. DRIP PROFILE CAP		KVM2314A	MIND.MAPS DRIP TRAY CAP	<table border="1"> <thead> <tr> <th>Code</th> <th>Description</th> <th>Qty</th> <th>UOM</th> </tr> </thead> <tbody> <tr> <td>VM2314A0</td> <td>6 S. DRIP PROFILE CAP</td> <td>1</td> <td>PZ</td> </tr> </tbody> </table>	Code	Description	Qty	UOM	VM2314A0	6 S. DRIP PROFILE CAP	1	PZ								
Code	Description	Qty	UOM																		
VM2314A0	6 S. DRIP PROFILE CAP	1	PZ																		
LP1019A	6 SERIES L200 LED LIGHT BAR - E415		KLP1019A	L200 E415 LED LIGHT BAR KIT	<table border="1"> <thead> <tr> <th>Code</th> <th>Description</th> <th>Qty</th> <th>UOM</th> </tr> </thead> <tbody> <tr> <td>IP1385A1</td> <td></td> <td>0.900</td> <td>M</td> </tr> <tr> <td>LP1019A0</td> <td>6 SERIES L200 LED LIGHT BAR - E415</td> <td>1</td> <td>PZ</td> </tr> <tr> <td>VM1058A1</td> <td></td> <td>0.900</td> <td>M</td> </tr> </tbody> </table>	Code	Description	Qty	UOM	IP1385A1		0.900	M	LP1019A0	6 SERIES L200 LED LIGHT BAR - E415	1	PZ	VM1058A1		0.900	M
Code	Description	Qty	UOM																		
IP1385A1		0.900	M																		
LP1019A0	6 SERIES L200 LED LIGHT BAR - E415	1	PZ																		
VM1058A1		0.900	M																		





COMPONENT			SPARE PART																														
Code	Description	Image	Code	Description	Components list																												
LP1025A	L=415 LED LIGHT BAR COVER		KLP1025A	L415 MM NO LED LIGHT HOLDER KIT	<table border="1"> <thead> <tr> <th>Code</th> <th>Description</th> <th>Qty</th> <th>UOM</th> </tr> </thead> <tbody> <tr> <td>IP1385A1</td> <td></td> <td>0.900</td> <td>M</td> </tr> <tr> <td>LP1025A0</td> <td>L=415 LED LIGHT BAR COVER</td> <td>1</td> <td>PZ</td> </tr> <tr> <td>VM1058A1</td> <td></td> <td>0.900</td> <td>M</td> </tr> </tbody> </table>	Code	Description	Qty	UOM	IP1385A1		0.900	M	LP1025A0	L=415 LED LIGHT BAR COVER	1	PZ	VM1058A1		0.900	M												
Code	Description	Qty	UOM																														
IP1385A1		0.900	M																														
LP1025A0	L=415 LED LIGHT BAR COVER	1	PZ																														
VM1058A1		0.900	M																														
VN1177A	CONTROL BOARD COOLING FAN		KVN1177A	CONTROL BOARD COOLING FAN KIT	<table border="1"> <thead> <tr> <th>Code</th> <th>Description</th> <th>Qty</th> <th>UOM</th> </tr> </thead> <tbody> <tr> <td>VN1177A0</td> <td>CONTROL BOARD COOLING FAN</td> <td>1</td> <td>PZ</td> </tr> </tbody> </table>	Code	Description	Qty	UOM	VN1177A0	CONTROL BOARD COOLING FAN	1	PZ																				
Code	Description	Qty	UOM																														
VN1177A0	CONTROL BOARD COOLING FAN	1	PZ																														
VM2316A	CONTROL BOARD COOLING FAN HOLDER		KVM2316A	PANEL COOLING FAN SUPPORT KIT	<table border="1"> <thead> <tr> <th>Code</th> <th>Description</th> <th>Qty</th> <th>UOM</th> </tr> </thead> <tbody> <tr> <td>VM2316A0</td> <td>CONTROL BOARD COOLING FAN HOLDER</td> <td>1</td> <td>PZ</td> </tr> </tbody> </table>	Code	Description	Qty	UOM	VM2316A0	CONTROL BOARD COOLING FAN HOLDER	1	PZ																				
Code	Description	Qty	UOM																														
VM2316A0	CONTROL BOARD COOLING FAN HOLDER	1	PZ																														
CE1285A	EMI ROUND FERRITE MOD.2643801502																																
CE1275A	CONNECTION CABLE POWER - CONTROL		KCE1275A	CONNECTING CABLE KIT	<table border="1"> <thead> <tr> <th>Code</th> <th>Description</th> <th>Qty</th> <th>UOM</th> </tr> </thead> <tbody> <tr> <td>CE1285A0</td> <td>EMI ROUND FERRITE MOD.2643801502</td> <td>1</td> <td>PZ</td> </tr> <tr> <td>CE1290A0</td> <td>EXTRACTABLE FEMALE TERMINAL CPF 5/4</td> <td>1</td> <td>PZ</td> </tr> <tr> <td>CE1455A0</td> <td></td> <td>4</td> <td>PZ</td> </tr> <tr> <td>CE1725A0</td> <td></td> <td>3</td> <td>M</td> </tr> <tr> <td>CE1735A0</td> <td></td> <td>4</td> <td>PZ</td> </tr> <tr> <td>CE1755A0</td> <td></td> <td>1</td> <td>PZ</td> </tr> </tbody> </table>	Code	Description	Qty	UOM	CE1285A0	EMI ROUND FERRITE MOD.2643801502	1	PZ	CE1290A0	EXTRACTABLE FEMALE TERMINAL CPF 5/4	1	PZ	CE1455A0		4	PZ	CE1725A0		3	M	CE1735A0		4	PZ	CE1755A0		1	PZ
Code	Description	Qty	UOM																														
CE1285A0	EMI ROUND FERRITE MOD.2643801502	1	PZ																														
CE1290A0	EXTRACTABLE FEMALE TERMINAL CPF 5/4	1	PZ																														
CE1455A0		4	PZ																														
CE1725A0		3	M																														
CE1735A0		4	PZ																														
CE1755A0		1	PZ																														



COMPONENT			SPARE PART																						
Code	Description	Image	Code	Description	Components list																				
0B1106A	XEVC-0511-E DOOR EXTERNAL LEFT COLUMN		0B1106A0	XEVC-0511-E DOOR EXTERNAL LEFT COLUMN																					
0B1108A	XEVC-0511-E DOOR EXTERNAL RIGHT COLUMN		0B1108A0	XEVC-0511-E DOOR EXTERNAL RIGHT COLUMN																					
0B1107A	XEVC-0511-E DOOR INTERNAL LEFT COLUMN																								
0B1109A	XEVC-0511-E DOOR INTERNAL RIGHT COLUMN																								
PE2042A	MM ONE VERSION CONTROL BOARD		KPE2042A	MIND.MAPS ONE CONTROL BOARD KIT	<table border="1"> <thead> <tr> <th>Code</th> <th>Description</th> <th>Qty</th> <th>UOM</th> </tr> </thead> <tbody> <tr> <td>PE2042A0</td> <td>MM ONE VERSION CONTROL BOARD</td> <td>1</td> <td>PZ</td> </tr> <tr> <td>PE2042A1</td> <td>MM ONE VERSION CONTROL BOARD</td> <td>1</td> <td>PZ</td> </tr> <tr> <td>VI2000A0</td> <td>SCREW M4X22 TCB+ INOX</td> <td>4</td> <td>PZ</td> </tr> <tr> <td>VM2147A0</td> <td>ESD SPONGE PINK SMOOTH 410X343X15 M</td> <td>1</td> <td>PZ</td> </tr> </tbody> </table>	Code	Description	Qty	UOM	PE2042A0	MM ONE VERSION CONTROL BOARD	1	PZ	PE2042A1	MM ONE VERSION CONTROL BOARD	1	PZ	VI2000A0	SCREW M4X22 TCB+ INOX	4	PZ	VM2147A0	ESD SPONGE PINK SMOOTH 410X343X15 M	1	PZ
Code	Description	Qty	UOM																						
PE2042A0	MM ONE VERSION CONTROL BOARD	1	PZ																						
PE2042A1	MM ONE VERSION CONTROL BOARD	1	PZ																						
VI2000A0	SCREW M4X22 TCB+ INOX	4	PZ																						
VM2147A0	ESD SPONGE PINK SMOOTH 410X343X15 M	1	PZ																						





COMPONENT			SPARE PART														
Code	Description	Image	Code	Description	Components list												
CE1053B																	
CE1052A	CABLE CONNECTION CONTROL - USB MM 750MM		KCE1052A	CONTROL BOARD-USB 650 CONN. CABLE KIT	<table border="1"> <thead> <tr> <th>Code</th> <th>Description</th> <th>Qty</th> <th>UOM</th> </tr> </thead> <tbody> <tr> <td>CE1052A0</td> <td>S6 USB CONNECTION CABLE LONG</td> <td>1</td> <td>PZ</td> </tr> <tr> <td>CE1052A1</td> <td>CABLE CONNECTION CONTROL - USB MM 750M</td> <td>1</td> <td>PZ</td> </tr> </tbody> </table>	Code	Description	Qty	UOM	CE1052A0	S6 USB CONNECTION CABLE LONG	1	PZ	CE1052A1	CABLE CONNECTION CONTROL - USB MM 750M	1	PZ
Code	Description	Qty	UOM														
CE1052A0	S6 USB CONNECTION CABLE LONG	1	PZ														
CE1052A1	CABLE CONNECTION CONTROL - USB MM 750M	1	PZ														
0B1216A			0B1216A0														
0B1217A																	
0B1122A	6 SERIES DOOR LOWER FRAME SHAPE		0B1122A0	6 SERIES DOOR LOWER FRAME SHAPE													